

SoundExpert[®] 821/721 **Sound Level Meter**

Reference Manual



Larson Davis

SoundExpert® 821/721 Reference Manual

Copyright

Copyright 2022-2023, by PCB Piezotronics, Inc. This manual is copyrighted, with all rights reserved. The manual may not be copied in whole or in part for any use without prior written consent of PCB Piezotronics, Inc.

Disclaimer

The following paragraph does not apply in any state or country where such statements are not agreeable with local law:

Even though PCB Piezotronics, Inc. has reviewed its documentation, PCB Piezotronics Inc. makes no warranty or representation, either expressed or implied, with respect to this instrument and documentation, its quality, performance, merchantability, or fitness for a particular purpose. This documentation is subject to change without notice, and should not be construed as a commitment or representation by PCB Piezotronics, Inc.

This publication may contain inaccuracies or typographical errors. PCB Piezotronics, Inc. will periodically update the material for inclusion in new editions. Changes and improvements to the information described in this manual may be made at any time.

Safety

If the equipment is used in a manner not specified by Larson Davis, the protection provided by the equipment may be impaired.

Recycling

PCB Piezotronics, Inc. is an environmentally friendly organization and encourages our customers to be environmentally conscious. When this product reaches its end of life, please recycle the product through a local recycling center or return the product to:



PCB Piezotronics, Inc.
Attn: Recycling Coordinator
1681 West 820 North
Provo, Utah, USA 84601-1341

Initial release date: June 15, 2023

Warranty

For warranty information, go to the [Larson Davis Product Warranty](#) page.

Contact Larson Davis

Website

www.larsondavis.com

Worldwide Corporate Headquarters

Larson Davis - a PCB Piezotronics division

3425 Walden Avenue

Depew, NY 14043-2495 USA

Toll-free (in the US): 888-258-3222

Phone: 716-926-8243

USA fax: 716-926-8215

E-mail: sales@larsondavis.com



Chapter 1	Product Overview	1
1.1	Hardware Overview	
1.2	Package Contents	
1.2.1	SoundExpert 721 or 821	
1.3	Available Options and Accessories	
1.3.1	Firmware Options	
1.3.2	Hardware Options and Accessories	
1.3.3	Ordering Information	
Chapter 2	Getting Started	9
2.1	Assembling Your Meter	
2.1.1	Connecting the Preamplifier and Microphone	
2.1.2	Connecting or Disconnecting the Preamplifier From the Meter	
2.2	Powering the Meter	
2.2.1	Powering On, Off, or Sleeping the Screen	
2.2.2	LED Status Light	
2.2.3	Using Battery Power	
2.2.4	Charging Batteries by External Power	
2.3	Calibrating the Meter	
2.3.1	About Acoustic Calibration	
2.3.2	Calibrating Your Instrument	
2.3.3	About Scheduling Factory Calibration	
2.4	Display Overview	
2.4.1	Understanding Status Bar and Indicators	
2.4.2	Navigating the Meter's Display	
2.4.3	Tools Menu Overview	
2.4.4	Display Settings	
2.5	Working With Internal Storage	
Chapter 3	Meter Settings	24
3.1	Selecting Settings	
3.2	Measurement Settings	
3.3	System Settings	
3.4	Exceedance Settings	
3.5	Calibration Settings	
3.6	Mode Control Settings	
3.7	Dosimetry Settings	

3.8 Ln Settings	
3.9 Community Noise Settings	
3.10 Markers Settings	
Chapter 4	Managing Measurement Data Files 37
4.1	Utilizing the Files View
4.1.1	Viewing a Measurement Data File
4.2	Managing SD Card Storage
4.2.1	Preparing a MicroSD Card For Use
Chapter 5	System Tools and Utilities 40
5.1	Utilizing the Meter Lock
5.2	About This Meter
5.3	Setting the Meter Date / Time
5.4	Troubleshooting the 721 or 821
5.5	Troubleshooting File Storage
Chapter 6	Software, Firmware, and Options 43
6.1	Updating the G4 LD Utility Software
6.2	Upgrading 721 or 821 Firmware or Options
Chapter 7	Noise Monitoring Systems Configuration 45
7.1	Package Contents
7.2	EPS/NMS048 Configuration Guide
7.3	Assembling Travel Packs
7.3.1	Assembly
7.3.2	Assemble EPS2116
7.3.3	The assembly of the EPS48-OPT1
7.4	Hardware and Firmware for Noise Monitoring Systems
7.4.1	Firmware Options
7.4.2	Hardware Options and Accessories
Appendix A	Technical Specifications A-1
A.1	Instrument Hardware Specifications
A.1.1	Compliance or Standards Met
A.1.2	Hardware Physical Specifications
A.1.3	Typical Electrical Frequency Response
A.1.4	Microphone Model 377B02 Filter Response and Corrections

- A.1.5 Microphone Model 375A04 Filter Response and Corrections
- A.1.6 Hardware Interface Specifications
- A.1.7 USB Client Interface Specifications
- A.1.8 Bluetooth™ Low Energy Interface
- A.1.9 AC/DC Output Specifications
- A.1.10 Wireless Charger Specifications
- A.1.11 External DC Power Supply Specifications
- A.1.12 Battery Power Specifications
- A.1.13 Instrument Date and Time Specifications
- A.1.14 Data Storage Specifications
- A.1.15 Electrostatic Discharge Specifications
- A.1.16 Environmental Conditions Specifications
- A.1.17 Mechanical Vibration Effects Recommendations
- A.1.18 Care and Cleaning
- A.1.19 Electromagnetic Compatibility Effects
- A.1.20 FCC/IC Compliance

A.2 Instrument Performance Specifications

- A.2.1 SLM Performance Specifications
- A.2.2 Measurement System Specifications

A.3 Model PRM721 and PRM821 Specifications

A.4 Octave Band Analysis Specifications

A.5 Directional Response

- A.5.1 XY Plane Frequency Response
- A.5.2 XZ Plane Frequency Response
- A.5.3 Directional Response Tables Without Windscreen

Appendix B Measuring Sound Using IEC 61672-1 B-1

B.1 IEC 61672-1 Section 9.3

Appendix C Glossary C-1

Chapter 1 Product Overview

The SoundExpert® 821 or 721 from Larson Davis is a precision sound level meter that is compatible with a variety of accessories, which makes it an ideal hand-held instrument for a wide range of acoustic tests. Additionally, the touchscreen interface makes this SLM as easy to use as your smart phone for acoustic applications, such as:

- City, construction, or airport monitoring for compliance with community noise ordinance
- Industrial Hygiene studies
- Product noise evaluation
- Production line acoustic testing
- Nuisance noise study (wind farm, entertainment, etc.)
- Site assessment
- Environmental noise study
- Mining and industrial operations and noise exposure

The instrument, with noted accessories, performs the following operations and more:

- Dosimetry with customizable measurement setup (on enabled units)
- Displays “Overall” measurement metrics for the current measurement
- Attended or unattended noise monitoring for short or long term
- Charging via AC or DC external power with the internal battery charger
- 1/1 Octave and 1/3 Octave filter analysis (on enabled units)

In this module:

1.1	Hardware Overview	1-2
1.2	Package Contents	1-3
1.3	Available Options and Accessories	1-5

1.1 Hardware Overview

Figure 1-1 Main Body: Front and Back



Figure 1-2 Main Body: Bottom Connectors

1. The **Audio Port** (output only) is a TRRS 3.5 mm audio jack. Alternatively, this port may be used to output a correlating voltage to the measured signal. See **3.3 System Settings**.

2. **USB 2.0** full-speed interface, USB-C connector. It is used for communication, full meter control, charging, and downloading data to PC using the CBL242-03 cable.

3. The **External Power Connector** is a 2.5 mm 12 V DC power connector for an external power source.



1.2 Package Contents

The SoundExpert 721 or 821 and accessories are shipped in protective packaging. We recommend that you verify that all parts and accessories for the configuration you selected are contained in your shipment.

Please report any damage immediately to Larson Davis, a division of PCB Piezotronics, Inc. (See contact information on the back page of the manual.) We also recommend retaining the packaging for safe shipment for calibration service.

1.2.1 SoundExpert 721 or 821



Item Description

Item Description	
1. SoundExpert 821/721	Class 1 Acoustic SLM with Community Noise Class 2 Acoustic SLM with Community Noise
2. 377B02/375A04 Microphone	½-inch free-field, pre-polarized microphone, 50 mV/Pa
3. PRM821/PRM721	Preamplifier
4. CCS060 Case (Optional)	Hard shell carrying case with fitted foam.
4. X21-SD-8GB	Removable Memory MicroSD Card 8 GB Industrial-grade
5. LD USB Drive: <i>Not for data storage</i>	Includes: G4 LD Utility software, <i>SoundExpert Reference Manual</i> , Digital Calibration Certificates
6. WS001	3 ½-inch windscreen to be placed over the microphone and preamp
7. CBL242-03 Cable	USB-C to C with USB-A adapter

CAUTION:
Mic and preamp
are sensitive to
static electricity

1.3 Available Options and Accessories

1.3.1 Firmware Options

The following options are available to purchase from your sales representative.

Table 1.1 Optional Firmware Packages

Dosimetry (X21-DOS)	<i>Description:</i> Noise exposure measurements and metrics compliant with a variety of occupational safety standards.-
Octave Band Analysis (X21-OB3)	<i>Description:</i> Simultaneous, real-time 1/1 & 1/3 Octave Frequency Analysis for the range of 6.3 Hz to 20 kHz. Compliant with IEC 61260:2014 Class 1 and ANSI S1.11-2014 Class 1 standards.
Bluetooth Disabled (X21-NBT)	<i>Description:</i> Disables Bluetooth connectivity during the time the setting is enabled.
Agency Approval (821ENV-LNE/PTB)	<i>Description:</i> When installed and enabled, the Agency Approval firmware enables you to produce measurement data that is approved by the following agencies: LNE or PTB. When in use, the “LNE” or “PTB” icon displays in the status bar <i>Available For:</i> SoundExpert 821 Models only

LEARN MORE For more information on installing and enabling these firmware options, see

6.2 Upgrading 721 or 821 Firmware or Options.

1.3.2 Hardware Options and Accessories

The SoundExpert 721 or 821 is adaptable to a wide range of acoustic measurement applications when equipped with the needed accessory sensors, adapters, and protective accessories. The following table contains only a few examples of available hardware options. For a complete listing of standard and system accessories, see **1.3.3 Ordering Information**

Table 1.2 Hardware Options and Accessories

Description	Options Available
Accessory Kit Options	<p>Class 1 Accessory kit (X21-ACC) for SoundExpert 821</p> <ul style="list-style-type: none"> • Case (CCS060) • Power supply (PSA045) • Class 1 calibrator (CAL200) • Windscreen (WS001)
	<p>Class 2 Accessory kit (X21-ACC1) for SoundExpert 721</p> <ul style="list-style-type: none"> • Case (CCS060) • Power supply (PSA045) • Class 2 calibrator (CAL150) • Windscreen (WS001)

Table 1.2 Hardware Options and Accessories (Continued)

Description	Options Available
Calibrator Options	Larson Davis Class 1 Calibrator; 94/114 dB @ 1 kHz (CAL200) Larson Davis Class 2 Calibrator; 94/114 dB @ 1 kHz (CAL150)
microSD Card Access Door	Replacement door (X21-DOOR)
Equivalent Electrical Impedance Adapter Options	12 pF, BNC Input Adapter for ½-inch microphone (ADP090). This adapter is used for electrical testing.
	BNC In-Line, Low Pass Filter, 75kHz (ADP092) This adapter acts as a series capacitor with the same capacitance as the microphone it replaces. If you're making a square wave pulse measurement, include a 75kHz, low pass, T-filter with the adapter.

Accessory Cables

- Microphone Extension Cable, shielded: (EXCXXX) where XXX is the length in feet (Available in 10, 20, 50, 100, and 200-foot lengths)
- Wireless charge pad Qi/WPC-compatible receiver (PSA046) with USB cable
- Cable, 2.5 mm power connector to Anderson Powerpole for outdoor noise monitoring system (CBL241-01)

1.3.3 Ordering Information

Additional information including can be found on the Larson Davis Website:

[Configuration Guide](#)

[Sound Expert Page](#)

Table 1.3 SoundExpert Sound Level Meters

Part Number	721ENV	721ENV-D	821ENV	821ENV-D
Model	721	721	821	821
Class	2	2	1	1
Time History Logging	✓	✓	✓	✓
Measurement History	✓	✓	✓	✓
Community Noise Metrics	✓	✓	✓	✓
OBA (1/1 and 1/3 Bands)		✓		✓

Table 1.4 SoundExpert Order Item Details

Part Number	Description
721ENV	SoundExpert Model 721 class 2 sound level meter with logging, measurement history, free-field microphone (50mV/Pa), preamplifier (PRM721) & USB-C cable (CBL242-03)
721ENV-B	SoundExpert Model 721 class 2 sound level meter without microphone, preamplifier or accessories except USB-C cable (CBL242-03). Meter body, X21-SD-8G, and USB-C cable only
721ENV-D	SoundExpert Model 721 class 2 sound level meter with logging, measurement history, 1/1 & 1/3 octave filters, free-field microphone (50mV/Pa), preamplifier (PRM721), X21-SD-8G & USB-C cable (CBL242-03)
821ENV	SoundExpert Model 821 class 1 sound level meter with logging, measurement history, free-field microphone (50mV/Pa), preamplifier (PRM821), X21-SD-8G & USB-C cable (CBL242-03)
821ENV-B	SoundExpert Model 821 class 1 sound level meter without microphone, preamplifier or accessories except USB-C cable (CBL242-03). Meter body, X21-SD-8G, and USB-C cable only
821ENV-D	SoundExpert Model 821 class 1 sound level meter with logging, measurement history, 1/1 & 1/3 octave filters, free-field microphone (50mV/Pa), preamplifier (PRM821), X21-SD-8G & USB-C cable (CBL242-03)
CBL242-03	USB-C to USB-C cable with USB-A Adapter
CCS060	Hard shell shipping and carrying case for SoundExpert Models 721 & 821 and Spartan Models 721 & 821 sound level meters
PRM721	Preamplifier, 1/2", for SoundExpert 721 and Spartan 721
PRM821	Preamplifier, 1/2", for SoundExpert 821 and Spartan 821
PSA045	Universal AC power supply with USB-C output connector. Does not include USB cable (CBL242-03)
PSA046	Qi charger pad with USB-C connector. Pad only, does not include USB cable (CBL242-03) or power supply (PSA045).
X21-ACC	Accessory kit for SoundExpert 721/821 and Spartan 721/821 sound level meters. Includes case (CCS060), power supply (PSA045), USB-C cable (CBL242-03), Class1 calibrator (CAL200) & windscreen (WS001)
X21-ACC1	Accessory kit for SoundExpert 721 and Spartan 721 sound level meters. Includes case (CCS060), power supply (PSA045), USB-C cable (CBL242-03), Class 2 calibrator (CAL150) & windscreen (WS001)
X21-DOOR	Replacement memory cover for models 721 & 821
X21-DOS	Firmware option for SoundExpert 721 and 821 to add computation of human exposure to noise metrics (dose)

Table 1.4 SoundExpert Order Item Details (Continued)

Part Number	Description
X21-NBT	Firmware option for SoundExpert 721/821 and Spartan 721/821 to disable internal Bluetooth
X21-OB3	Add 1/1 and 1/3 octave filters to Spartan 721/821 or SoundExpert 721/821
X21-SD-8GB	8 GB, industrial grade microSD memory chip for use in SoundExpert 721/821 and Spartan 721/821
X21-SP	Screen protector for SoundExpert 721/821. Includes 2 screen protectors with wipes and cleaning cloth.
DVX017	Bluetooth USB Adapter for PC

Chapter 2 Getting Started

In this module:

2.1	Assembling Your Meter	-10
2.1.1	Connecting the Preamplifier and Microphone	
2.1.2	Connecting or Disconnecting the Preamplifier From the Meter	
2.2	Powering the Meter	-11
2.2.1	Powering On, Off, or Sleeping the Screen	
2.2.2	LED Status Light	
2.2.3	Using Battery Power	
2.2.4	Charging Batteries by External Power	
2.3	Calibrating the Meter	-13
2.3.1	About Acoustic Calibration	
2.3.2	Calibrating Your Instrument	
2.3.3	About Scheduling Factory Calibration	
2.4	Display Overview	-14
2.4.1	Understanding Status Bar and Indicators	
2.4.2	Navigating the Meter's Display	
2.4.3	Tools Menu Overview	
2.4.4	Display Settings	
2.5	Working With Internal Storage	-23

2.1 Assembling Your Meter

The meter is designed with a removable preamplifier and microphone. This allows you to remove and store these accessories in protective cases for transport or when not in use.

In this section:

- [2.1.1 Connecting the Preamplifier and Microphone](#)
- [2.1.2 Connecting or Disconnecting the Preamplifier From the Meter](#)

2.1.1 Connecting the Preamplifier and Microphone

CAUTION Do not handle the microphone and preamplifier without observing the following cautions:

- Avoid static discharge to the pogo pin (e.g. ground yourself)
- Do not use excessive force
- Gripping tightly or screwing threads tightly is unnecessary
- Do not remove the microphone grid cap and expose the diaphragm
- Do not allow dust or debris to collect in preamplifier or microphone

FIGURE 2-1 Microphone and Preamplifier Threaded Assembly

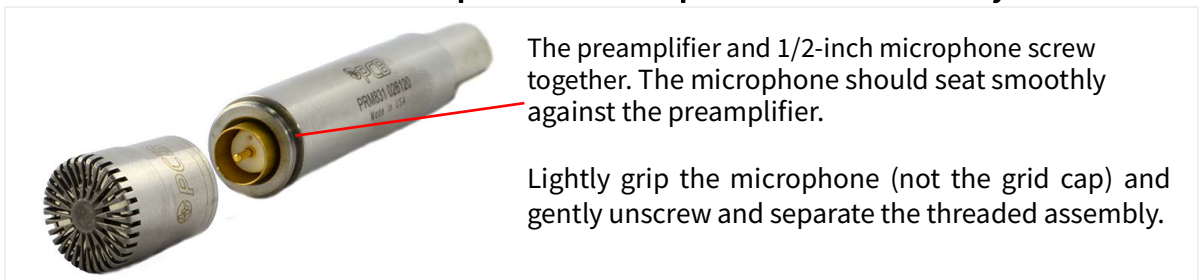

2.1.2 Connecting or Disconnecting the Preamplifier From the Meter

To Connect the Preamplifier:

The preamplifier is marked to enable correct alignment when connecting to the meter. Observe each step of the following process to prevent unnecessary damage.

CAUTION Do not attempt to screw the preamplifier into the meter's preamplifier housing.

Step 1. Look for an engraved line along the length of the preamplifier. When correctly assembled, the engraved line aligns with the top of the **preamp release** button (Figure 2-2).

Step 2. With the marks on both pieces aligned, insert the 5-pin connector of the preamplifier into the preamp housing and beyond the preamp seal *until it latches with a small audible click*.

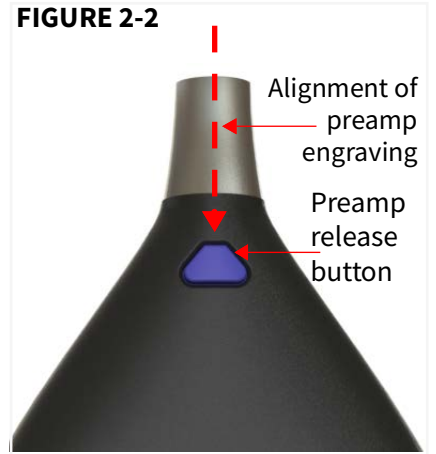

To Disconnect the Preamplifier:

Press and hold the **preamp release** button, then pull the preamplifier assembly from the meter.

2.2 Powering the Meter

The meter is engineered to be power-conscious. Indications, status details, and other power-related details appear throughout the meter interface. This simplifies the task of monitoring power while you work.

In addition, the meter provides power-saving settings also described in this section.

The meter will not allow measurements to begin until the system is stabilized.

In this section:

- [2.2.1 Powering On, Off, or Sleeping the Screen](#)
- [2.2.2 LED Status Light](#)
- [2.2.4 Charging Batteries by External Power](#)
- [2.3 Calibrating the Meter](#)

2.2.1 Powering On, Off, or Sleeping the Screen

Power On: Press and hold the **Power** button  for 1 to 2 seconds to power on the meter. Power indications for the meter are located on the Live tab, which is the first screen you see after powering on.

Power Off: Press and hold the **Power** button  for 4 to 5 seconds to power off the meter. The display will show a countdown.

When not actively using the meter, *quick press* the power button to put the screen to sleep. *Quick press* the power button again to wake the screen. The display will automatically sleep based on the Display Sleep Time setting.

2.2.2 LED Status Light

The meter uses the front LED to display the colors shown in *Table 2.3* to indicate the associated meter state. You can disable this light in the settings. See [3.3 System Settings](#)

TABLE 2.3





Color Blink (every 2 seconds)	Meter State
Green	Running
Yellow	Paused
White	Stopped/Reset
Red	Power button is pressed

2.2.3 Using Battery Power

Battery Charging/Status Indicators

The battery icon (top right of the meter status bar) indicates the current battery level and charging status by the color and volume. An animated charging bolt appears over the battery icon when charging. When using battery power, the battery icon indicates the state of the battery from depleted to fully charged (left to right).

TABLE 2.4 Battery Indicator States

Indicator	Description
	Fully charged battery; 100% capacity
	Fully charged battery; 100% capacity and connected to power source the charging bolt stays on and does not animate.
	When connected to a power source, with the battery at less than 100% capacity, the animated charging bolt appears. The battery charges until full or until the meter is disconnected from external power.
	Low Battery
	Less than 1% charge remaining; Dead Battery Notice displays when attempting to power on the meter. Connect to a power source via charging cable or place meter on wireless charging pad.

You can also find the percent remaining of the internal battery on the Live tab System card, along with the current power source.

2.2.4 Charging Batteries by External Power

Use one of the following external power sources to simultaneously power the meter and charge the meter's internal batteries:

- USB-C cable (CBL242-03)
- Wireless charging pad (PSA046)
- 12V power through the External Power Connector

Utilizing External Power Connections

TAKE NOTE The operating temperature range is –4 to 140 °F (–20 to 60 °C). For additional detail, see [A.1.16 Environmental Conditions Specifications](#).

When utilizing the included USB-C cable with a 5V, 3A supply, the meter’s battery reaches maximum charge in under 8 hours.

Charging via the Wireless Charging Pad

When utilizing the included universal power supply and optional wireless charging pad (PSA046), the 721 or 821 reaches maximum charge in under 13 hours. View additional details in [A.1.10 Wireless Charger Specifications](#)

- Step 1.** Rest the back case of the meter on the wireless charging pad. This positions the meter’s internal charging coils over the pad. For the location of the internal charging coils, review the back label of the meter.
- Step 2.** Connect the pronged power connector for the charging pad to an external power source (wall outlet). When the meter is powered on and charging, the on-screen battery icon displays an animated charging bolt (see *Table 2.4*).

2.3 Calibrating the Meter

In this section:

- [2.3.1 About Acoustic Calibration](#)
- [2.3.2 Calibrating Your Instrument](#)
- [2.3.3 About Scheduling Factory Calibration](#)

2.3.1 About Acoustic Calibration

In acoustic calibration, the sound level calibrator (CAL200) provides an acoustic signal of a known amplitude (94/114 dB) and frequency (1000Hz) to the microphone which is used as a reference to adjust the system sensitivity. In the meter, the system sensitivity updates with each calibration.

We recommend that you calibrate prior to each measurement. Transporting or even repositioning may introduce variations in temperature and humidity, which impact the accuracy of the meter, microphone, and preamplifier.

We recommend that you calibrate prior to each measurement. Transporting or even repositioning may introduce variations in temperature and humidity, which impact the accuracy of the meter, microphone, and preamplifier.

TAKE NOTE An acoustic calibrator creates an acoustic pressure field of a known amplitude. The 377B02 and 375A04 are free field microphones, not pressure microphones, so a small correction should be applied for the most accurate acoustic calibration. In the calibration settings of the 821/721, adjust the output level of the calibrator down by 0.12 dB from the level shown on the calibrator's calibration certificate to account for this. For example, if the calibration sheet says that the calibrator output is 114.02 dB, then the value entered into the meter for the calibrator's output should be 113.90 dB.

2.3.2 Calibrating Your Instrument

The meter has an automatic calibration feature that allows you to calibrate from any view as long as the meter is stopped and reset. You may turn off the auto-calibration feature in the **Calibration** settings. You may also begin a calibration from the **Tools**  **Calibrate**.

Step 1. Insert the microphone into the opening at the bottom of the calibrator.

Step 2. Turn on the calibrator.

TAKE NOTE The calibrator turns off after one minute. Utilize within that time or press the power button again.

Step 3. The meter displays the “Calibrating” dialog, which shows the **Measurement** level (dB), the **Calibrator** level setting (dB), and the detected change (Delta dB).

Step 4. Select **Accept** when complete.

TAKE NOTE If you receive an error message (such as Calibration Out of Range), select **Cancel**. Verify that the calibrator level and your meter’s calibrator setting are the same. Ensure the calibrator is seated correctly on the microphone. Then perform the calibration again. If the problem persists, contact support.

2.3.3 About Scheduling Factory Calibration

Service and certified internal calibration for your meter at the factory may be scheduled at your convenience. We recommend either annual or biennial factory calibration.

The data from the factory calibration is stored in the meter and stated in the documentation that returns with your meter.

2.4 Display Overview

In this section:

- **The status bar at the top of the screen displays the measurement, and battery status as shown in Figure 2-5.**
- **2.4.2 Navigating the Meter’s Display**
- **2.4.3 Tools Menu Overview**
- **2.4.4 Display Settings**

2.4.1 Understanding Status Bar and Indicators

The status bar at the top of the screen displays the measurement, and battery status as shown in *Figure 2-5*.

FIGURE 2-5 Elements of the Status Bar



1. Live Metric

You may change the metric displayed by tapping the name and select from the popup list.

2. Live Metric Level (dB)

The live level of the selected live metric.

3. Current Date, Time

The date and time of the meter. Connect to G4 to update.

4. Overload Indicator

An overload occurs when the sound level exceeds the upper limit of the meter. The **Overload Indicator** flashes to indicate an overload is occurring. The indicator remains solid (not flashing) indicating an overload has occurred during the current measurement. Reset the measurement to clear the indicator. Tap **Tools**  → **Reset** to reset the measurement.

5. Under Range Indicator





The meter displays the **Under Range Indicator** when the sound level is too low to measure accurately. For additional detail about the range of your model, see [A.2.1 SLM Performance Specifications](#).

6. Bluetooth Indicator

The Bluetooth Indicator displays only when the meter has an active Bluetooth connection.

7. Meter State Indicator

Table 2.1 State

Meter State	
	Running
	Paused
	Stopped
	Reset
	Error

Caution Status

A caution or warning icon displays in the center of the meter status bar when the microSD card is not responding to the meter.

FIGURE 2-6 Caution Status

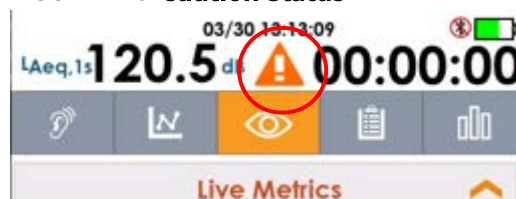

While the caution icon displays, most meter actions are disabled. Do the following, to address it:

- Power down the meter.
- Discharge any electrostatic build-up.
- Open the microSD card access door on the bottom rear of the meter, and remove and reinsert the SD card.
- Replace the microSD card access door, and then power on the meter.

If an SD card is installed and the caution icon is present, first reboot the meter. If this does not clear the caution status, you will need to backup any valuable data on the SD card and format it. To do this, do the following:

- Immediately power down the meter.
- Insert the microSD card into a PC to download saved files
- Format the microSD card in the PC and replace the microSD card.

To format the SD card without backing up saved files, do the following:

- On the meter, select **Tools**  → **System Utilities** → **Format and Restore**.
- Confirm your selection, and the meter clears any saved data and reformats the SD card.

8. Battery and Charge Status

Indicates the internal battery level and whether the meter is charging.

If a Low Battery Shut-Down occurs, a Session Log entry is created to note that the low power shut-down process interrupted the measurement.

When the meter is connected to an external power source, the battery begins charging. If the meter has enough power to boot it will do so automatically. If not, you will need to press the power button.

2.4.2 Navigating the Meter's Display

The main screen contains five tabs, represented by and accessible from the Tab Selection bar shown in this figure.

FIGURE 2-7 Main Tab Navigation

Tap an icon
or
swipe left/right
to move from tab to tab.

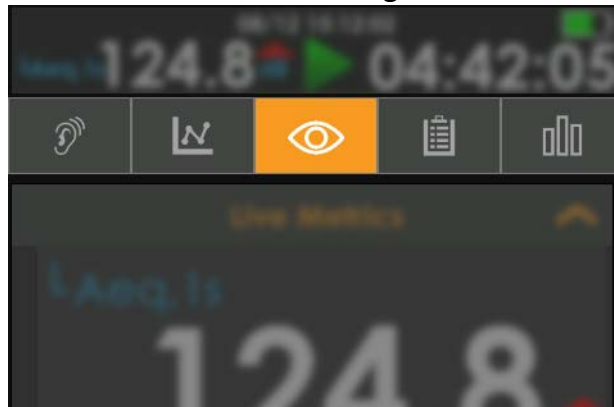

Each tab contains cards that can be collapsed or expanded, as shown in *Figure 2-9*. The Live tab  is the first screen displayed when the meter is powered on.

TABLE 2.8 Description of Tabs







Dosimetry 	Time History (TH) 	Live 	Overall 	Measurement 
Worker noise exposure data	The periodic sampled data	Current noise levels and other meter data	Summary data collected while running	The measurement data for each Run/Stop or timed segment

FIGURE 2-9 Live Tab Screen, Example

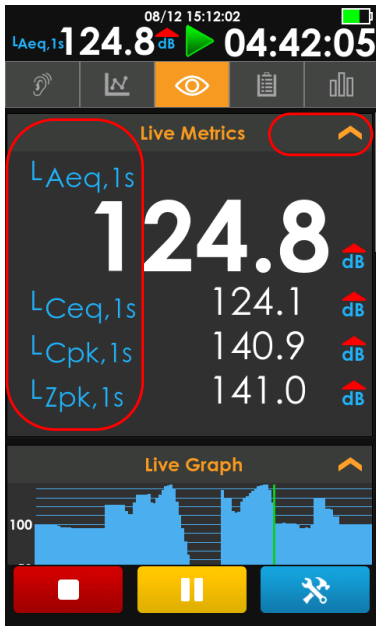

1. The **Live Metrics** info card is expanded in this figure; you can tap  to collapse the card and tap  to expand it.

2. In many places in the display, you may choose which metrics you wish displayed. Tap the metric label and select from the list popup.

With the  **Live** tab active, on the **Live System** card, you can view the estimated battery run time, battery percentage, power source, and other current system details.

FIGURE 2-10 Live View Info Cards



The data on the display updates once per second. When the meter is stopped, the Live data will continue to update while the other tabs will display the data from the current measurement.

The green vertical line on the Live Graph indicates the most recent sample from the meter.

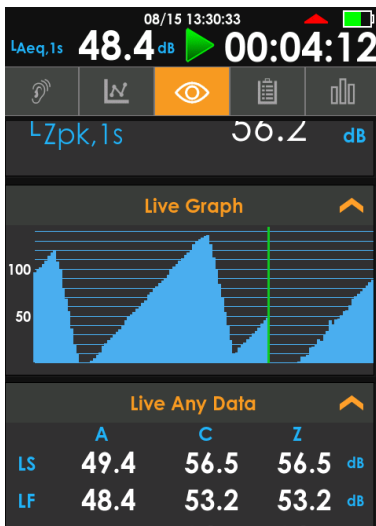
Dosimetry Tab

FIGURE 2-11 Dosimetry

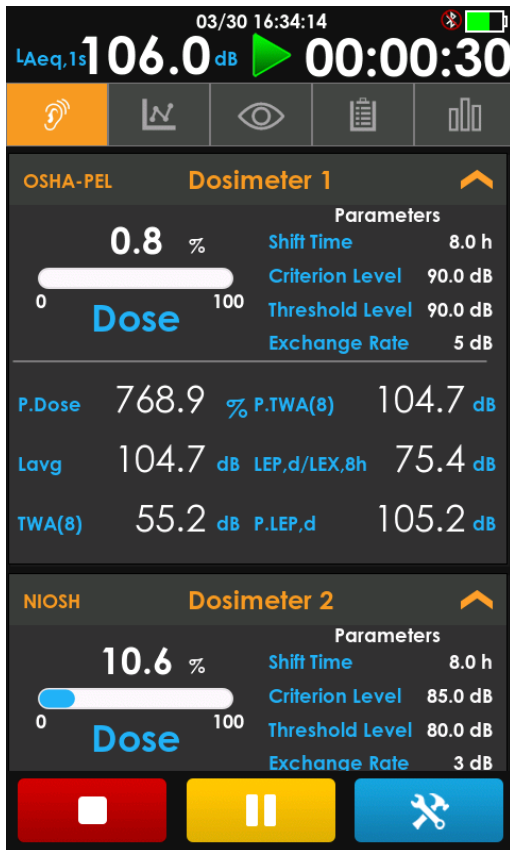

The Dosimetry View displays no information until a measurement starts with at least one enabled dosimeter. This is available only with the X21-DOS option installed.

The meter displays dose metrics according to the parameters selected in the Dosimetry Settings (on the meter at **Tools** → **Settings** → **Dosimetry**).

Time History Tab

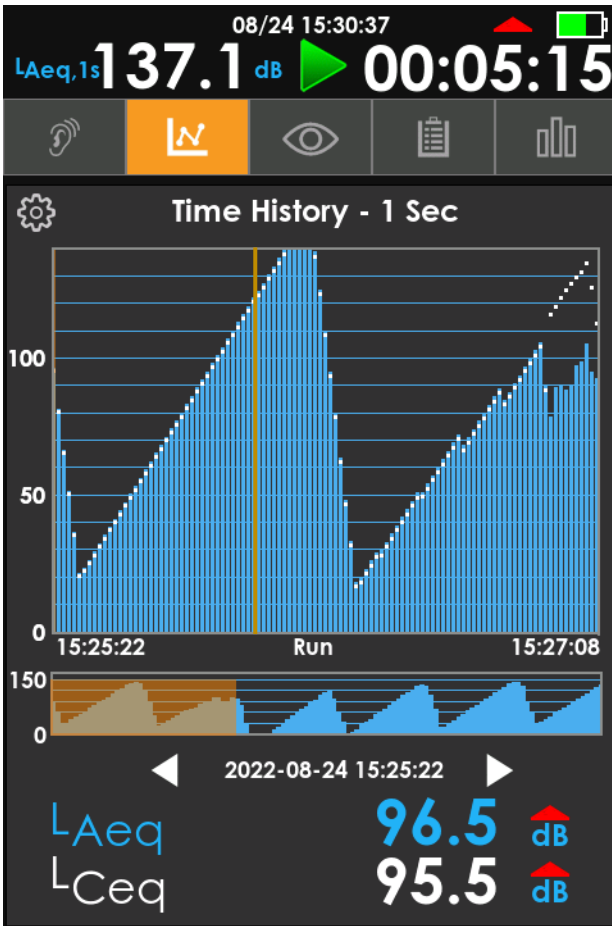

FIGURE 2-13 Time History

The Time History (TH) view displays customizable data from the current measurement. The display updates once per second regardless of the selected Time History period.

1. Near the bottom, **two customizable metrics** (L_{Aeq} and L_{Ceq}) show levels for the currently highlighted record. You can tap the metrics to change them.
2. The vertical gold indicator line in the graph shows the currently highlighted time history record. The meter displays the selected date and time with the two metrics' values.
3. Use the **left and right selector arrows** to change the highlighted record or tap on the graph to select a new record.
4. The gold highlight in the overall time history (the lower graph) shows the position of the section in the upper graph. Tap anywhere in the lower graph to navigate through the data.
5. To edit the graph's y-axis, tap the gear icon, then tap the min or max value input to edit them. To accept and save, tap outside the number keyboard when you have finished.

Overall Tab



FIGURE 2-14 Overall

The Overall tab is similar to the Live tab except the data displayed is for the entire file. You can also find Session Log at the bottom of the tab.

Overload Info Card

When an overload occurs on the meter, overload icons appear throughout the system. The Overall screen indicates an overload when the meter has been overloaded at any point during the current measurement.

Community Noise Info Card

The Community Noise details provide two authoritative exposure ratings for collected sources of sound (L_{DEN} , L_{DN}). The ratings provide different calculations for exposure during daytime, evening, or nighttime hours. For more information, see **Community Noise Equivalent Level (CNEL, LDEN)**.

Measurement Tab

The Measurement History bar graph indicates the most recent history interval records in the current measurement. It shows the overall level for each record.

FIGURE 2-15 MH Bar Graph

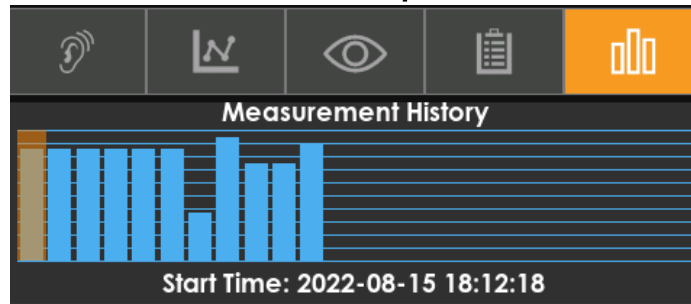

Tap on each bar to navigate through the records. This tab is very similar to the Overall tab with several of the same cards but the data displayed comes from each measurement history interval record.

2.4.3 Tools Menu Overview

Select **Tools**  to access the following menus and settings on the meter.

Settings

Set up measurement and system settings.

See **Module 3 Chapter 3 Meter Settings**.

Markers

See **3.10 Markers Settings**.

System Utilities

Reboot the meter, calibrate DC Out, and format or restore file system

See **Module 5 Troubleshooting the 721 or 821**.

Reset

Select **Reset** to clear any unsaved data on the meter. Meter will clear overall data and be able to start a new measurement after 2 seconds. A preamp disconnection or connection will delay a run for approximately 15 seconds.

Calibrate

Calibrate the system for accurate measurements.

See **2.3 Calibrating the Meter**.

Lock

Lock the meter's screen to prevent tampering.

See **5.1 Utilizing the Meter Lock**.

Files

List all data files stored on the inserted microSD card.

See **Module 4 Chapter 4 Managing Measurement Data Files.**

About

View system information.

See **5.2 About This Meter.**

2.4.4 Display Settings

To open the Display Settings, swipe down from the top of any screen.

FIGURE 2-16 Display Settings





The meter has a multi-color, back-lit LCD touchscreen, which allows you to choose light or dark display theme and adjust the brightness. Tap to toggle the **Light/Dark Theme icon**  / . The Dark theme is featured in this manual.

FIGURE 2-17 721/821 Light and Dark Display Themes



Screen Sleep

You can *click* the power button to put the screen to sleep. And *click* again to wake up the screen.

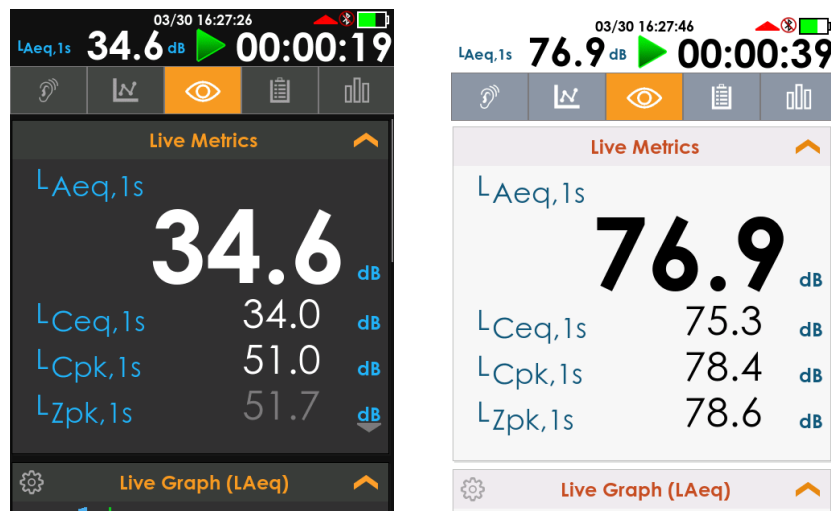
2.5 Working With Internal Storage

The meter comes with an 8-GB, industrial-grade microSD card installed behind the microSD card access door.

CAUTION Do not attempt to remove the microSD card while the meter is powered on. This may result in data corruption or complete loss.

CAUTION Do not open the microSD card access door while the meter is powered on. This increases the risk of internal damage to the meter due to electrostatic discharge (ESD).

FIGURE 2-18 microSD Card Placement

The meter contains a layered card structure, which accommodates the microSD card in the top layer and an unused slot beneath it.

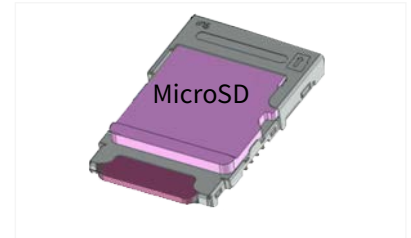

Step 1. Orient the microSD card with copper contacts down.

Step 2. Place the card on the top layer and slide it towards the microphone.

TAKE NOTE When the meter displays the **caution icon**  in the Meter Status bar, this indicates the card is not accessible to the meter. For more information, see **Caution Status**.



Chapter 3 Meter Settings

The 721/821 makes measurements based on the values selected from the Settings screen. Prior to beginning a measurement, configure the settings suited to your application, as shown in this section.

TAKE NOTE The settings for making a measurement are organized in cards on the Settings screen. To open or close a card tap the golden down and up arrows.

Within a card, tap inside a field to view and select from available values near the bottom of the screen. Tap outside the selection box to close it.

When modifying text fields, a keyboard will popup. Each time you modify a text field, you will have to retype the desired text. For supported languages, to enter text using characters not in the Latin alphabet, use G4 or LD Atlas.

Settings are not available to edit while running a measurement. If you need to edit settings with a measurement in progress, tap **Stop**  + **Store** . Or to clear the current measurement data without saving, tap **Tools**  → **Reset**. When “Store on Stop” is enabled, simply stop the measurement. You may then edit settings and make a new measurement.

In this module:

3.1	Selecting Settings	-----	25
3.2	Measurement Settings	-----	25
3.3	System Settings	-----	26
3.4	Exceedance Settings	-----	28
3.5	Calibration Settings	-----	29
3.6	Mode Control Settings	-----	30
3.7	Dosimetry Settings	-----	31
3.8	Ln Settings	-----	33
3.9	Community Noise Settings	-----	35
3.10	Markers Settings	-----	36

3.1 Selecting Settings

To prepare the 721/821 for an SLM measurement, complete this section.

On the meter, tap **Tools**  → **Settings**. The **Measurement** settings appears, as shown in *Figure 3-1*.

3.2 Measurement Settings

FIGURE 3-1 Measurement Settings Card

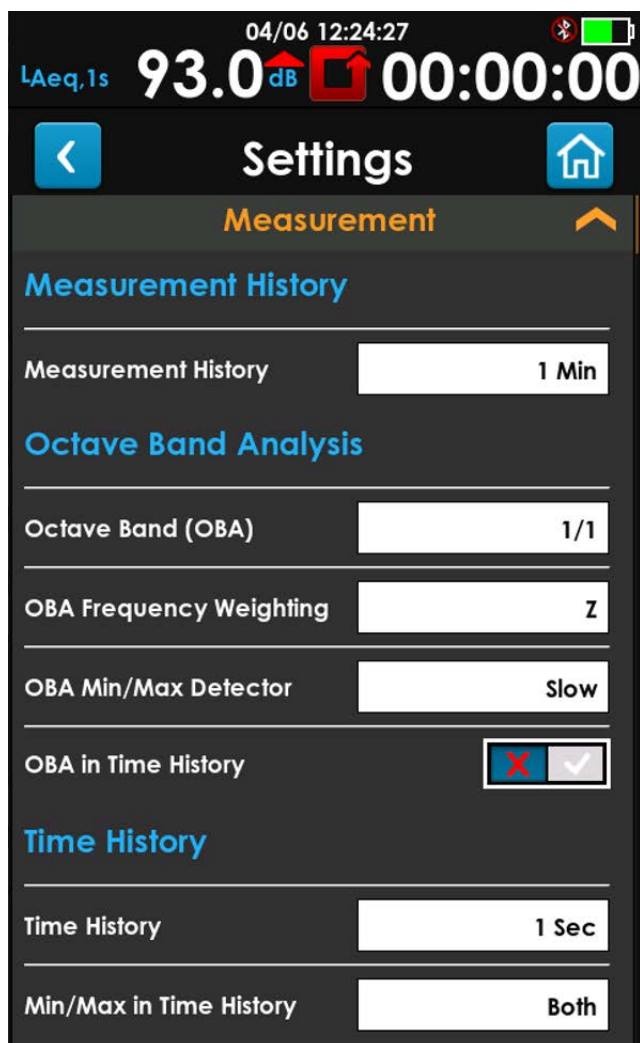

- **Measurement History**
Enables you to segment the data gathered between Run and Stop into measurement intervals at the specified duration (1 min to 6 hour). Measurement intervals are individual records within a single data file.
- **Octave Band (OBA)**
Includes full or third Octave Bands in the overall summary. Turning off OBA will hide other OBA settings.
- **OBA Frequency Weighting**
Select the weighting (A, C, or Z) for the Octave Bands.
- **OBA Min/Max Detector**
Specifies the detector (Impulse, Fast, or Slow) used for the computation of Lmin and Lmax.
- **OBA in Time History**
Select whether to include Octave Band data with each Time History record.
- **Time History**
Enables the recording of a table of metrics at the selected regular intervals. The meter will display a graph of the metrics in the time domain. Choose “Off” to disable Time History.
- **Min/Max in Time History**
Choosing Min, Max, or Both will enable the Time History to include Min, Max or Both for all available metrics, including OBA.

3.3 System Settings

FIGURE 3-2 System Card

System	
Device Name	Spartan 821
Device Desc.	Field Study A
Passcode	
LED Status Light	<input type="checkbox"/>
Auto Off (30 min)	<input type="checkbox"/>
DC Out Enable	<input type="checkbox"/>
External Disconnect (V)	10.8
Display Sleep Time	1 Min
Language	English
Decimal Preference	Period (.)

- **Device Name**
Included in the summary page of the data file view.
- **Device Desc.**
A description of the device that is included in the summary page of the data file. You can only edit it in G4 or LD Atlas.
- **Passcode**
This code restricts access in G4 and LD Atlas when connecting over BLE so that users cannot tamper with the meter settings. You may use this in conjunction with the meter Lock to further protect your meter and data. The code can be up to 8 digits (0-9). Leaving this blank means no passcode.
- **LED Status Light**
Enable or disable the status led on the meter.
- **Auto Off (30 min)**
When the meter is not taking a measurement and Auto Off is enabled, then the meter will power off automatically after 30 minutes, except when charging.
- **DC Out Enable**
When DC Out is enabled, the meter continuously directs the voltage equivalent of the microphone input signal to the meter's Audio/DC Output on the bottom of the meter. By connecting the cable CBL139 to this port, it's possible to output the current signal voltage from the BNC connector to a multimeter or other device.

The sensitivity of the DC Output is 10 mV/dB with 1 V equivalent to 100 dB re 20 μ Pa.

The DC Output signal follows your selected **Exceedance Frequency Weighting** and **Exceedance Detector**. To verify or edit these settings on the meter, expand the **Exceedances** card from the **Tools**  **Settings** screen.

Calibrating and Adjusting DC Output

- Go to **Tools**  **System Utilities**.
- Select **Calibrate DC Out**.
- Press **Begin Calibration** to initiate. The meter will output 1V DC. Measure the output with a Digital Multi-Meter (DMM) and adjust the offset value until reading is equal to 1V.
- Close the popup any time to cancel.

- **External Disconnect (V)**

To prevent over discharging and damaging external batteries connected to the **External Power Connector**, the meter disconnects from the supply when the measured voltage drops below the set External Disconnect Voltage. For example, a 12 volt battery will continue to supply the meter until its voltage drops below the set voltage (default 10.5V meter's measured voltage). The supply resumes connection when the voltage rises above the set value plus 500 mV. The meter will continue to run on internal batteries until they discharge.

TAKE NOTE There is approximately a 0.3 V drop from the external supply to the meter's measured voltage, so the meter will report a voltage 0.3 V lower than what can be measured externally.

- **Display Sleep Time**

The meter's display will stay illuminated for the selected time, with a default of 1 minute. You can set it to 30 seconds to reduce battery usage. The screen will darken slightly 10 seconds before it is about to shut off. Once the display turns off, you can click the power button to cause the display to come back on. You may also turn the screen off by clicking the power button to save power.

- **Language**

Set the meter's language for the UI elements.

- **Decimal Preference**

Choose to display a period (.) or a comma (,) for the decimal separator.

3.4 Exceedance Settings

FIGURE 3-3 Exceedance Card

Exceedance
⤴

Exceedance Settings

Frequency Weight

Detector

Peak Frequency Weight

Exceedance Triggers

SPL 1 (dB)

SPL 2 (dB)

Peak 1 (dB)

Peak 2 (dB)

Peak 3 (dB)

- **Frequency Weight**
Select the Frequency Weighting (A, C, or Z) for the SPL trigger counters.
- **Detector**
Specifies the peak detector (Impulse, Fast, or Slow) used for exceedances.
- **Peak Frequency Weighting**
Select the peak frequency weighting (A, C, or Z) for the Peak trigger counters.
- **Exceedance Triggers**

The meter has five exceedance counters: two SPL counters and three Peak counters. Enter levels for which the meter will trigger an exceedance for each SPL and Peak.

For each exceedance, the meter stores a threshold level, counter and duration. The count is the number of times each parameter has exceeded the preset level. The duration is the total accumulated duration of all exceedances for a specific parameter. The file data displays this information in the summary tab.

Exceedances
⤴

L _{C1}	#	Duration	L _{Zpk}	#	Duration
>85 dB	0	00:00:00	>135 dB	0	00:00:00
>95 dB	0	00:00:00	>137 dB	0	00:00:00
			>140 dB	0	00:00:00

The Exceedance Triggers settings affect the data shown on the Exceedances card in Overall data.

3.5 Calibration Settings

FIGURE 3-4 Calibration Card

Calibration

Level (dB) 114.00

System Sensitivity (dB re 1V/Pa) -18.7

System Sensitivity (mV/Pa) 116.1

Corrections FF:FF

Auto Calibration

Microphone

Model 377B02

Device Name 377B02

Microphone Noise Level (dBA) 15.0

Nominal Sensitivity (dB re 1V/Pa) -26.0

Nominal Sensitivity (mV/Pa) 50.1

Serial Number

Preamp



Serial Number

- **Level**
Set the Calibrator output level.
- **System Sensitivity**
Set the system sensitivity either in dB re 1V/Pa or mV/Pa.
- **Correction**
Select the correction filter. See [A.1.4 Microphone Model 377B02 Filter Response and Corrections](#)
- **Auto Calibration**
Enable the meter auto calibration feature, which will detect when a calibrator tone is injected around the calibrator level while reset or stopped.
- **Microphone settings**
Select the microphone attached to the system and enter it's serial number to be stored with measurement data. Custom microphone information can be entered using the "Other" model option
- **Preamp Serial Number**
Enter the Preamp serial number. Supported Larson Davis preamp types are detected automatically

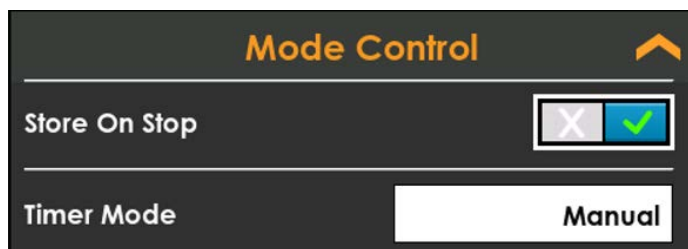
3.6 Mode Control Settings



- **Store On Stop**

With this setting enabled, the meter automatically stores the current measurement data when you tap the **Stop button**  or when a measurement ends. The **Stored button**  verifies the file is saved.

When Store On Stop is not enabled, select the **Stop button** once to end the measurement, then tap **Store**  to save measurement data.

- **Timer Mode**

Manual (Default): You begin and end measurements with the Run, Stop, Pause buttons.

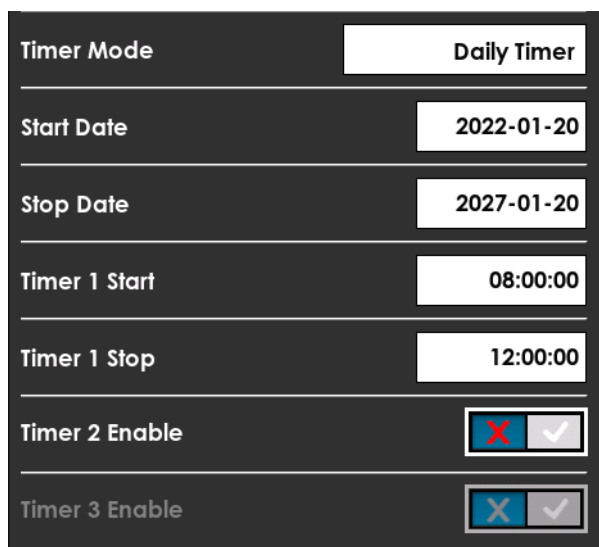

Timed Stop: Enter a value for **Duration** (hh:mm:ss). Tap **Run**  to begin.

Daily Timer: Each timer will trigger once per day between the Start and Stop



dates. Enter the Start and Stop dates for the timer cycle to begin and end. By selecting the Daily Timer mode at least one Timer will trigger daily. The Start and Stop for each Timer may not overlap with the previous Timer. The meter has the capacity to enable one, two, or three daily timers simultaneously.

TAKE NOTE The meter rejects duplicate Timer Start/Stop entries, and Timer 3 is not available when Timer 2 is disabled.

Continuous: The meter runs continuously and saves measurement data periodically according to the value you select for **Auto-Store Interval**. Tap **Run**  to begin and **Stop**  to end a continuous measurement. The meter automatically starts running on power up with this mode enabled.

3.7 Dosimetry Settings

Dosimetry settings apply to SoundExpert units equipped with the X21-DOS option only.

Tap to expand the **Dosimetry** card to add and remove dosimeters. Tapping the **Selected Dosimeter**, you can choose which of the four dosimeters to enable, disable and modify. Each dosimeter has the following options. While disabled, the meter will not display the dosimeter card. To see a virtual dosimeter on the meter ensure that it is enabled in these settings. See **Noise Dose (Dose)**

- **Dosimeter # Enable**

Where # is the currently selected dosimeter. When enabled, the other options will become visible to configure this dosimeter. The meter will record the necessary details for compliance with the chosen standard when selecting the associated **Configuration**. The remaining fields will be disabled.

You may select a **Custom** configuration that will allow you to change the other fields. When you choose a Configuration other than Custom, remaining values on the Dosimetry card are supplied according to the standards described in *Table 3.1*.

The 721/821 Virtual Dosimeters use a “Slow” exponential detector.

Dosimetry	
Selected Dosimeter	Dosimeter 1
Dosimeter 1 Enable	<input checked="" type="checkbox"/>
Configuration	OSHA-PEL
Title	OSHA-PEL
Mode	Dose

FIGURE 3-5 Custom Dosimeter

Configuration	Custom
Title	CUSTOM1
Mode	Dose
Exchange Rate	5 dB
Criterion (dB)	90.0
Threshold Enable	<input checked="" type="checkbox"/>
Threshold (dB)	90.0
Shift Time	8.0
Frequency Weight	A
Peak Frequency Weight	C

- Title**
 You may set the name of the custom configuration. G4 and LD Atlas displays this in the data file view under the **Summary** tab for **Virtual Dosimeters**.
- Mode**
 Choose between **Dose** and **ISO** modes.
- Exchange Rate**
 Choose from 3 dB to 6 dB. This value is only used when you choose Dose from the Mode selection. The Exchange Rate defines the ratio of exposure time to level. For example, if you choose 5 dB for this setting, and the sound field is constant, this means that an increase of 5 dB in the Time-Weighted Average (TWA) would result in the dose being doubled. A decrease of 5 dB in the TWA would result in the dose being 50% less

- Criterion (dB)**
 This value is only used when you choose Dose as the Mode. The level is used in the calculation of Dose, Projected Dose, TWA and Projected TWA. See **Projected Noise Dose, Noise Dose (Dose)**,
- Threshold Enable**
 Enable or disable the Threshold Level. This is only used when you choose Dose mode. When ISO is the selected mode, this setting is ignored and Threshold is not used.
- Threshold (dB)**
 Threshold Level (55-100 dB) is only used when you choose Dose as the Mode. Used to calculate the TWA and Projected TWA.

 TWA is a time-weighted average exposure to noise over a period of time (as opposed to a noise level measured at a specific point in time). For this measurement, any noise level under the Threshold Level is ignored and the exchange rate is taken into account. When the exchange rate is 3 dB, TWA(8) is the constant sound level over an 8-hour period that produces the same amount of acoustic energy as the actual sound level, only taking into account sound above the threshold level.
- Shift Time**
 The length of time in hours of the worker’s shift. This is used in the computation of Projected Dose, LEP’d, and TWA. See **Projected Time-Weighted Average, P.TWA(x), Projected Noise Dose**
- Frequency Weight**
 The frequency weighting used for all noise level calculations for this virtual dosimeter except for the peak frequency weighting, which has a separate weighting selection (A, C, or Z.). The detector for each frequency weighting is Slow. The LAeq metric can be displayed on Live and Overall pages.
- Peak Frequency Weight**
 Select the weighting (A, C, or Z) for the peak frequency.

TAKE NOTE The following table shows properties of the international standard configurations for virtual dosimeters 1, 2, 3, and 4. The Custom configuration is also an option for each dosimeter.

Table 3.1 Agency Standard Configuration Values

	OSHA-PEL	OSHA-HC	ACGIH	NIOSH	ISO 9612	Canada
Mode	Dose	Dose	Dose	Dose	ISO	ISO
Exchange Rate	5 dB	5 dB	3 dB	3 dB	3 dB	3 dB
Criterion Level	90.0 dB	90.0 dB	85.0 dB	85.0 dB	85.0 dB	85.0 dB
Threshold Enable	Enabled	Enabled	Enabled	Enabled	Enabled	Enabled
Threshold	90.0 dB	80.0 dB	80.0 dB	80.0 dB	87.0 dB	85.0 dB
Shift Time	8.0 hrs	8.0 hrs	8.0 hrs	8.0 hrs	8.0 hrs	8.0 hrs
Frequency Weight	A-Weighted	A-Weighted	A-Weighted	A-Weighted	A-Weighted	A-Weighted
Peak Frequency Weight	C-Weighted	C-Weighted	C-Weighted	C-Weighted	C-Weighted	C-Weighted
Detector	Slow	Slow	Slow	Slow	Slow	Slow

3.8 Ln Settings

The meter computes the Lns for overall data.

Ln Enable: Allows the meter to capture Ln data.

Ln Percent: Enter the percent for each of the six n values.

Ln Frequency Weight: Select the frequency weighting used for the Ln calculations.

Ln Detector: Select the detector used for the Ln calculations.

FIGURE 3-6 Ln Settings

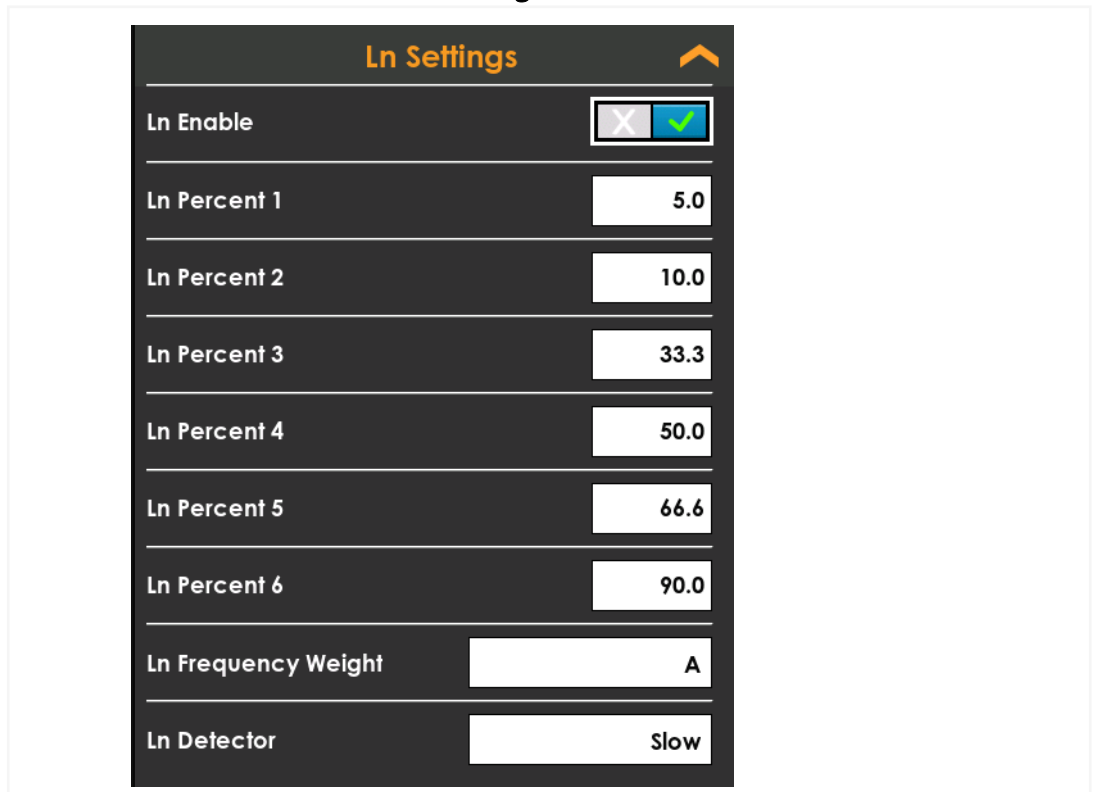



LEARN MORE For more information, see this “Appendix C: Glossary,”
Ln Value

3.9 Community Noise Settings

Among the parameters measured and displayed as part of data file sound level measurement, G4 displays the community noise descriptors L_{DN} and L_{DEN} . The Community Noise card defines the times and penalties to be used.

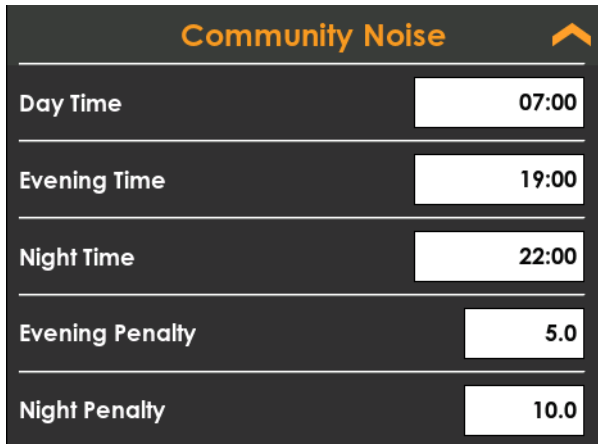
FIGURE 3-7 Custom Dosimeter



Community Noise 	
Day Time	07:00
Evening Time	19:00
Night Time	22:00
Evening Penalty	5.0
Night Penalty	10.0

- **Day Time**
The start of the day in hours:minutes using 24-hour notation. This also marks the end of penalties. Default 07:00.
- **Evening Time**
The time at which the evening penalty will begin. Default 19:00.
- **Night Time**
The Night Penalty will be applied after this time. Default 22:00.

- **Evening Penalty**
The penalty applied to the level measured during the time from Evening Time to Night Time.
- **Night Penalty**
The penalty applied to the level measured from Night Time to Day Time.

LEARN MORE For more information, see [Community Noise Equivalent Level \(CNEL, LDEN\)](#) and [Day-Night Average Sound Level \(DNL, LDN\)](#)



3.10 Markers Settings

The meter sound markers allow you to label segments of the resulting measurement data. One common application is to identify data impacted by human or animal interference during outdoor noise monitoring.

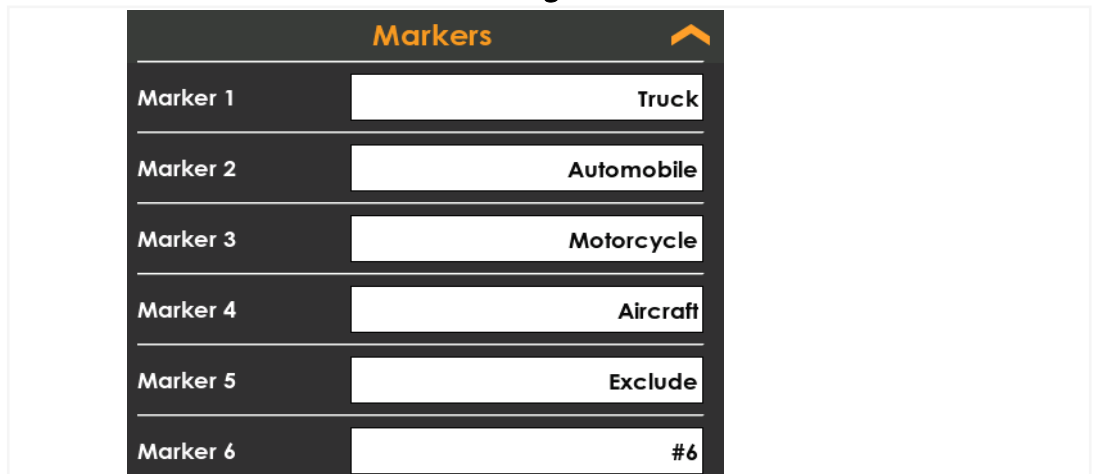
FIGURE 3-8 Marker Settings



Prior to beginning a measurement, edit marker labels to suit your purpose. Then during the measurement, mark the sound type as described in this section.

- Step 1.** Prior to the measurement, go to **Tools**  → **Settings** on the meter, and expand the **Markers** card.
- Step 2.** Verify or edit marker label fields to suit the measurement.
- Step 3.** Close the Settings screen to return to the **Live** view.
- Step 4.** During the measurement, go to **Tools**  → **Markers**. Select the marker at the appropriate time to label that segment in the resulting data file.

LEARN MORE To view markers in the data file, open the file in G4 LD Utility. For more information, see the *G4 LD Utility Manual* in G4 (**Help** → **Manuals** → **G4 LD Utility**) or from www.LarsonDavis.com.

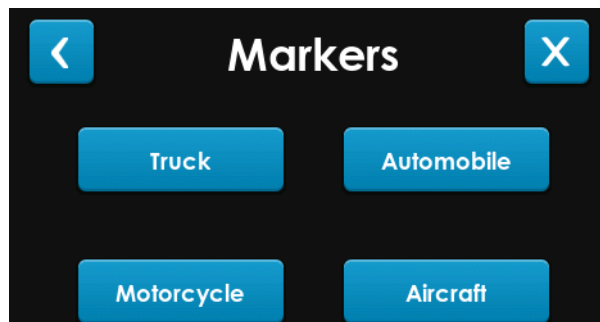

Chapter 4 Managing Measurement Data Files

A new data file is created or appended each time you manually or automatically store measurement results. The meter comes with industrial-quality internal storage, which can also be backed up to your PC via G4 LD Utility.

In this module:

- 4.1 Utilizing the Files View -----37
 - 4.1.1 Viewing a Measurement Data File
- 4.2 Managing SD Card Storage -----38
 - 4.2.1 Preparing a MicroSD Card For Use

4.1 Utilizing the Files View

The Files view is accessible on the meter even during a measurement. It lists the saved data files created with the meter. Recently saved files display at the top of the list.

TAKE NOTE G4 LD Utility software provides a larger visual display for resulting data files. For more information, see the *G4 LD Utility Manual*; available on the included LD USB drive or from www.LarsonDavis.com.

Step 1. Tap **Tools**  → **Files** to open the Files view.

FIGURE 4-1 721/821 Files View

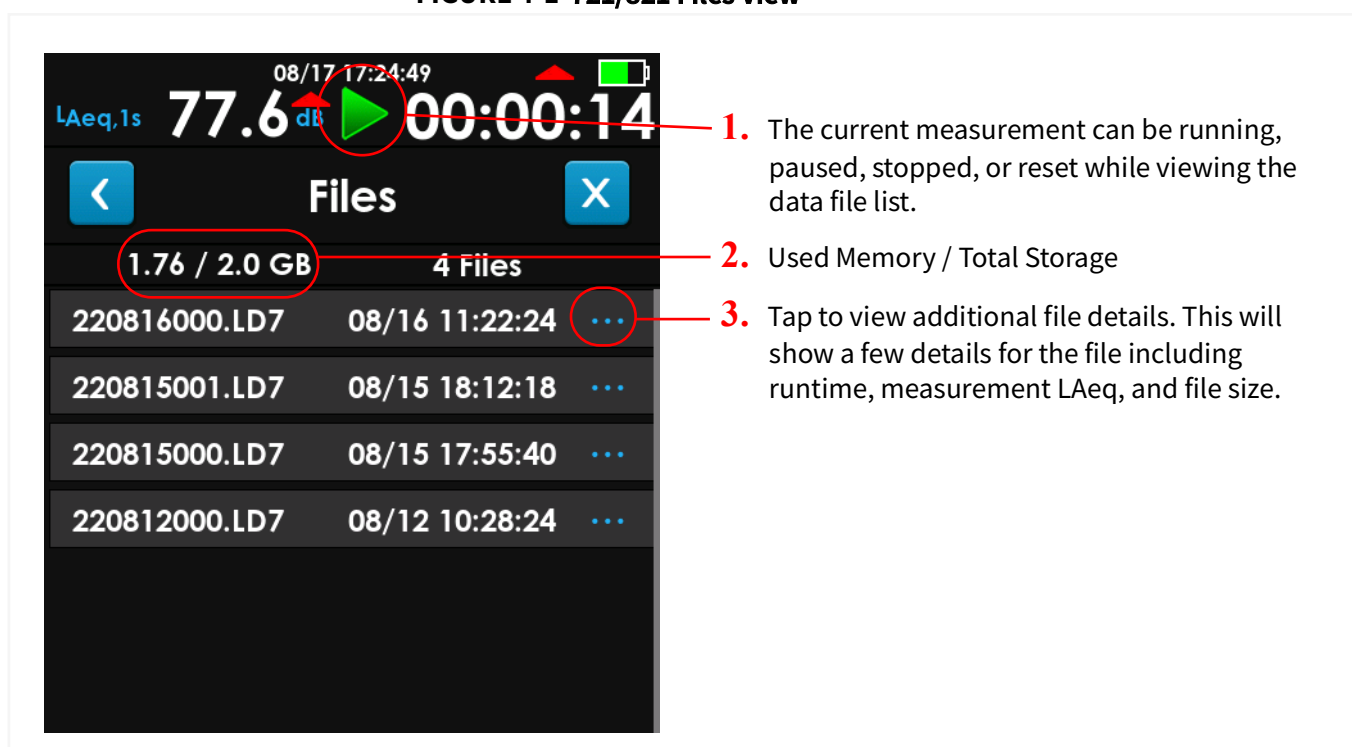

About File Naming Conventions

The meter files are easily identified by the “.LD7” extension. The meter automatically names saved files according to the following nine-digit convention: two digits each for the year, month, and day, followed by three digits to uniquely identify each file (up to 999, then alphanumeric up to ZZZ). For example:

FIGURE 4-2 Two digits for year, month, day; three for unique ID

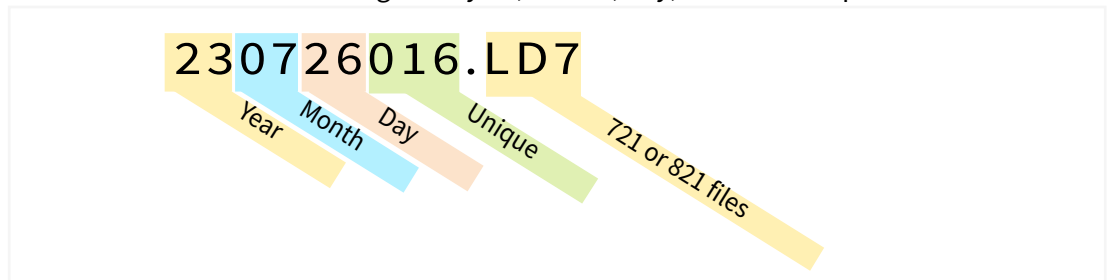

4.1.1 Viewing a Measurement Data File

To view measurement data files, connect to the meter via G4 LD Utility by using your PC.

LEARN MORE For more information, view the *G4 LD Utility Manual* in G4 (**Help** → **Manuals** → **G4 LD Utility**) or from www.LarsonDavis.com.

4.2 Managing SD Card Storage

CAUTION Do not attempt to remove the microSD card while the meter is powered on. This may result in data corruption or complete loss.

CAUTION Do not open the microSD card access door while the meter is powered on. This increases the risk of internal damage to the meter due to electrostatic discharge (ESD).

The meter is compatible with many microSD cards. We recommend the following best practices when interacting with microSD card storage:

- Choose an industrial-quality card, such as the one included with the meter
- Connect the meter often in G4 LD Utility; files downloaded to a PC via G4 provide reliable backup storage
- Discharge static buildup from your body each time before opening the microSD card access door
- New microSD cards must be formatted for use with the meter as described in **4.2.1 Preparing a microSD Card For Use**
- microSD cards filled to capacity may be reformatted for use with the meter as shown in **4.2.1 Preparing a microSD Card For Use**
- See **A.1.14 Data Storage Specifications** for more details about microSD card sizes that can be used

LEARN MORE For more information about G4 and backing up data files, view the *G4 LD Utility Manual* in G4 (**Help** → **Manuals** → **G4 LD Utility**) or from www.LarsonDavis.com.



4.2.1 Preparing a microSD Card For Use

Prepare a previously unused microSD card or reformat a card that is filled to capacity as shown in this section.

Before you begin:

- **CAUTION** Discharge static buildup from your body
- **WARNING** For microSD cards filled to capacity: insert the microSD card into a card reader (in your PC or other) and back up that data to your PC

TAKE NOTE This erases saved data on the inserted card, formats it for use with the meter, and restores all settings on the meter to factory defaults.

- Step 1.** With the meter powered off, insert the microSD card into the 721 or 821 via the microSD card access door.
- Step 2.** Power on the meter.
- Step 3.** From the  **Live** view, select **Tools**  → **System Utilities**.
- Step 4.** Select **Format and Restore**, then confirm your selection.

Chapter 5 System Tools and Utilities

The 721 or 821 provides system-wide tools and utilities that may optionally be used to facilitate measurements and to maintain or service the meter.

In this module:

5.1	Utilizing the Meter Lock	40
5.2	About This Meter	41
5.3	Setting the Meter Date / Time	41
5.4	Troubleshooting the 721 or 821	42
5.5	Troubleshooting File Storage	42

5.1 Utilizing the Meter Lock

Locking the meter temporarily restricts access to meter settings and prevents unintentional user changes. When locked, the meter and measurement status (run, stop, store) display, but can't be edited. Only the brightness and dark mode display settings (*swipe down from top*) may be changed when the meter is locked.

To lock or unlock the meter, complete this process.

Step 1. Set the passcode on the meter. To do this, do the following:

- From the Live view, tap **Tools**  → **Settings** → **System**.
- In the **Passcode** field, enter any combination of numbers up to 8 characters.
- Tap above the keyboard when finished.

Step 2. To lock the meter, do the following:

- From the Live view, tap **Tools**  → **Lock**.
- Enter the **Passcode** you previously set, then tap **Lock**. The meter displays the "Locked" screen.

TAKE NOTE While the screen is locked, you may choose to apply the screen sleep feature to conserve battery power. To engage screen sleep, *quick tap* the **Power** button. *Tap* again to view the screen.

Step 3. Unlock the meter, by using, "**Tap Here to Unlock.**"

- Enter the correct **Passcode** and tap **Unlock**.
- If you can't remember the passcode, you may reset it by connecting to the meter in G4.
- If you forgot your passcode, you can connect your meter to G4 via USB and reset your passcode. Connections over BLE will restrict your access.

LEARN MORE The meter can also be locked or unlocked in G4 (or LD Atlas for mobile). For more information view the *G4 LD Utility Manual* in G4 (**Help** → **Manuals** → **G4 LD Utility**) or from www.LarsonDavis.com.

5.2 About This Meter

The About menu contains details about the meter hardware, software, and firmware, and options; this includes regulatory compliance details, version, and issue dates.

Step 1. On the meter, tap **Tools**  → **About** to view the following information:

Table 5.1 About This Meter: Details and Dates

Serial #	Certification Date
Hardware Version	Manufacture Date
International Standards Compliance	Firmware Version with Date and Install Date
Options Available for This Model	Options Currently Installed On This Meter
Regulatory section containing the certified Bluetooth® radio modules in the meter	

5.3 Setting the Meter Date / Time

The meter date and time can be set via G4 using the Tools->Sync Clock.

To set the time using the meter :

Step 1. From the Live view, tap **Tools**  → **System Utilities** → **Set Date & Time**



Step 2. Use the Pick Date button to choose a date

Step 3. Use the Pick Time button to choose the time to set

Step 4. Tap apply to set the date and / or time

TAKE NOTE You can set the date by itself, the time by itself, or both

5.4 Troubleshooting the 721 or 821

The 721 or 821 System Utilities allow you to reboot the meter. This clears and resets the meter for use. Note that unsaved measurement data on the meter will be saved. To reboot the meter, do the following:

- Step 1.** On the meter, select **Tools**  → **System Utilities**.
- Step 2.** Select **Reboot Meter**. The meter is unavailable for less than 10 seconds during this process.

5.5 Troubleshooting File Storage

The 721 or 821 System Utilities allow you to troubleshoot issues with the memory card or associated meter settings. Specifically, reformatting the microSD card and restoring meter settings often resolves the issue. Note that unsaved measurement data on the meter is also cleared.

CAUTION Do not attempt to remove the microSD card while the meter is powered on. This may result in data corruption or complete loss.

To reformat the microSD card and restore meter settings, do the following:

- Step 1.** Power the meter off, and discharge accumulated electrostatic charge on your body.

CAUTION Do not open the microSD card access door while the meter is powered on. This increases the risk of internal damage to the meter due to electrostatic discharge (ESD).

- Step 2.** Open the microSD card access door, to remove or reinstall the microSD card in the meter.

TAKE NOTE If you have not recently connected the meter to your PC via G4 and downloaded meter files to your PC, back up your files by doing the following:

- a.** Insert the microSD card into an microSD card reader (in your PC or other) and save data files to your PC.
- b.** Reinstall the card in the meter.

- Step 3.** Replace the microSD card access door and power on the meter.

- Step 4.** Power up the meter. Then on the meter screen, select **Tools**  → **System Utilities**.

- Step 5.** Select **Format and Restore** and confirm your selection. The meter clears all saved data from the microSD card and reformats it for use; all meter settings (including any calibration adjustment) are reset to factory defaults.

Chapter **6** Software, Firmware, and Options

In addition to meter operation, the G4 LD Utility (G4) is also used to install firmware and option upgrades as shown in the following processes. For a complete list of available firmware (versions) and options (additional features or extended capability), see **1.3.1 Firmware Options**.

In this module:

6.1	Updating the G4 LD Utility Software -----	43
6.2	Upgrading 721 or 821 Firmware or Options -----	43

6.1 Updating the G4 LD Utility Software

Locate the G4 installer on the LD USB Drive included with your meter, or get the latest from www.LarsonDavis.com/G4.

6.2 Upgrading 721 or 821 Firmware or Options

Upgrading firmware and options are conducted from the same dialog using the following process.

Before you begin:

- Update G4, see **6.1 Updating the G4 LD Utility Software**
- Power on your meter and connect it to your PC via the included USB-C cable (CBL242-03).

Step 1. Launch G4 LD Utility.

- Step 2.** In the G4 Meters Panel, your meter (serial number) displays with a blue SLM icon when the meter is properly connected or a gray SLM icon when not connected.

FIGURE 6-1 721/821 in the G4 Meters Panel

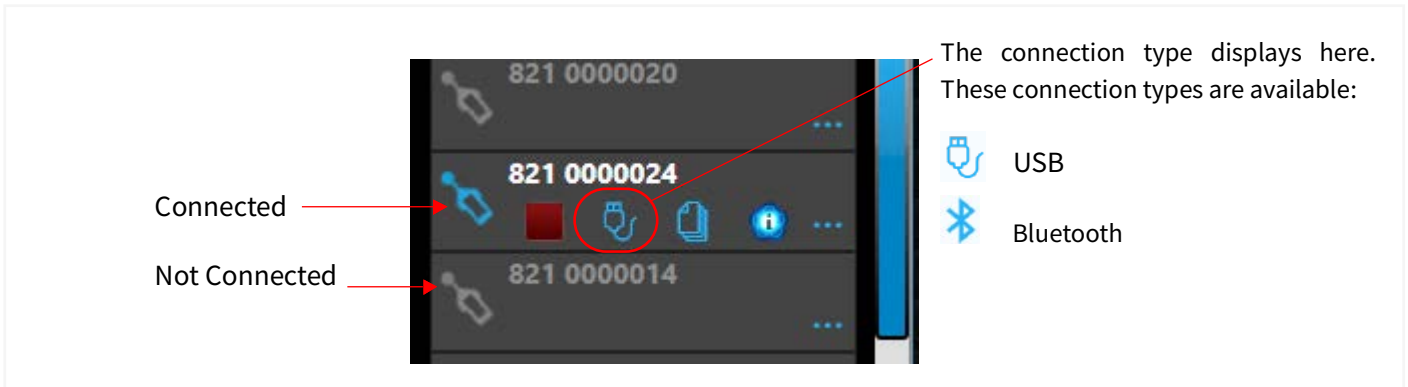

- Step 3.** Click the **Menu icon**  in-line with your meter, and select **Upgrade Firmware** or **Upload Options**. This opens the Upgrade Firmware or Upgrade Options window.

- Step 4.** In G4, the **Update All Selected Meters** checkbox is selected. Verify or edit checkboxes for the selected meters in the Meters Panel.

To update only the currently connected meter, deselect the **Upgrade All Selected Meters** checkbox.

- Step 5.** Click **Choose Firmware File** or **Choose Options File**. This opens the File Explorer to the default firmware/options folder. If you have updated G4 recently, these files will be the most recent firmware.

TAKE NOTE Firmware updates are frequently released. Update G4 regularly to obtain access to them. Options files are purchased through Larson Davis or via your LD representative.

- Step 6.** Select the “.fwx21” file (for firmware) or “.opx21” file (for options) you want to install. This opens the File Explorer to the default firmware folder.

- Step 7.** Navigate to the Desktop (or to the location of the 721/821 file you saved), select the file you want to install, and click **Open**. The options upgrade will begin automatically, the firmware upload requires step 8

- Step 8. (Upgrading firmware only):** Confirm your choice by clicking **Upload Firmware**. Immediately following the firmware update, the meter reboots. When the reboot is complete, G4 displays a confirmation that the firmware upgrade is complete.

- Step 9.** To confirm the installation, do the following:

- On 721/821, tap **Tools**  → **About** and view the displayed firmware version and install date, which should be today’s date. The installed options are also visible.

Chapter 7 Noise Monitoring Systems Configuration

In this module:

7.1	Package Contents	-----45
7.2	EPS/NMS048 Configuration Guide	-----49
7.3	Assembling Travel Packs	-----49
7.4	Hardware and Firmware for Noise Monitoring Systems	-----54

7.1 Package Contents

The Larson Davis Noise Monitoring Systems (NMS) and Environmental Protection Systems (EPS) include the meter and/or accessories which are shipped in protective packaging. We recommend that you verify the shipment contains all parts and accessories for the configuration you selected. Please report any damage or shortage immediately to Larson Davis. (See contact information on the back page of the manual.) We also recommend retaining the packaging for safe shipment for calibration service.

The SoundExpert 721/821 is type 1 compliant when using the EPS2116.

The SoundExpert 721/821 is available as part of a custom system or in a standard configuration. The following sections list contents for each standard configuration.

TABLE 7.1 NMS048 with Options. Each includes the EPS048-SLA with battery see Table 7.3 on page 47.

<p>NMS048-SLA</p> <p>377B02 Microphone</p> <p>PRM821 Preamplifier</p> <p>EPS2116 Outdoor microphone protection</p> <p>PSA045 USB power supply</p> <p>CBL242-03 USB-C cable</p> <p>SoundExpert Model 821</p> <p>EPS048-SLA SoundExpert 721/821</p>	<p>NMS048-SLA-S</p> <p>377B02 Microphone</p> <p>PRM821 Preamplifier</p> <p>EPS2116 Outdoor microphone protection</p> <p>PSA045 USB power supply</p> <p>CBL242-03 USB-C cable</p> <p>SoundExpert Model 821</p> <p>EPS048-SLA SoundExpert 721/821</p> <p>EPS048-OPT1 Add solar</p>
<p>NMS048-SLA-ACU</p> <p>377B02 Microphone</p> <p>PRM821 Preamplifier</p> <p>EPS2116 Outdoor microphone protection</p> <p>PSA045 USB power supply</p> <p>CBL242-03 USB-C cable</p> <p>SoundExpert Model 821</p> <p>EPS048-SLA SoundExpert 721/821</p> <p>EPS048-OPT2-U AC power – US & North America</p>	<p>NMS048-SLA-ACE</p> <p>377B02 Microphone</p> <p>PRM821 Preamplifier</p> <p>EPS2116 Outdoor microphone protection</p> <p>PSA045 USB power supply</p> <p>CBL242-03 USB-C cable</p> <p>SoundExpert Model 821</p> <p>EPS048-SLA SoundExpert 721/821</p> <p>EPS048-OPT2-E AC Power – Europe</p>

Item Contents

<p>1. NMS048-SLA</p>	<p>Includes SoundExpert Model 821/721, PRM821/721 Preamp and microphone, EPS048-SLA, PSA045 power supply, CBL242-03 USB-C cable, and EPS2116 microphone protection.</p>
<p>2. NMS048-SLA-S</p>	<p>Includes SoundExpert Model 821/721, PRM821/721 Preamp and microphone, EPS048-SLA, PSA045 power supply, CBL242-03 USB-C cable, EPS2116 microphone protection and EPS048-OPT1 see Table on page 48.</p>
<p>3. NMS048-SLA-ACU</p>	<p>Includes SoundExpert Model 821/721, PRM821/721 Preamp and microphone, EPS048-SLA, PSA045 power supply, CBL242-03 USB-C cable, EPS2116 microphone protection and EPS048-OPT2-U see Table on page 48</p>
<p>4. NMS048-SLA-ACE</p>	<p>Includes SoundExpert Model 821/721, PRM821/721 Preamp and microphone, EPS048-SLA, PSA045 power supply, EPS048-OPT2-E see Table on page 48, CBL242-03 USB-C cable, EPS2116 microphone protection.</p>

TABLE 7.2 Environmental Protection System (EPS048 and options)



Item Contents:

EPS048 - Base case and cables for outdoor use. Includes CCS061 SoundExpert ENV case, EXC010 10' (3 m) cable for preamp connection, CBL241-01 X21 power, and CBL225-01 battery cable.

TABLE 7.3 DC Power Kits for Environmental Protection System (EPS048)



Item Contents

1: EPS048-SLA	Includes BATT011 12-Volt Sealed Lead Acid battery kit SLA, 21 AH, EPS048 SoundExpert case, and PSA040 12-Volt indoor charger for SLA battery
2: EPS048-ALK	This kit uses D-Cell batteries to charge and supply power for the EPS/NMS048. Includes BAT024 D-Cell battery holder and EPS048 SoundExpert case.

CAUTION PSA040 is for indoor use only to charge the SLA battery from a wall outlet. Keep the case open when charging to prevent overheating system components. If you want outdoor AC power then please purchase the EPS048-OPT2-E/U.

TABLE 7.4 Optional Packages for Environmental Protection System (EPS048)

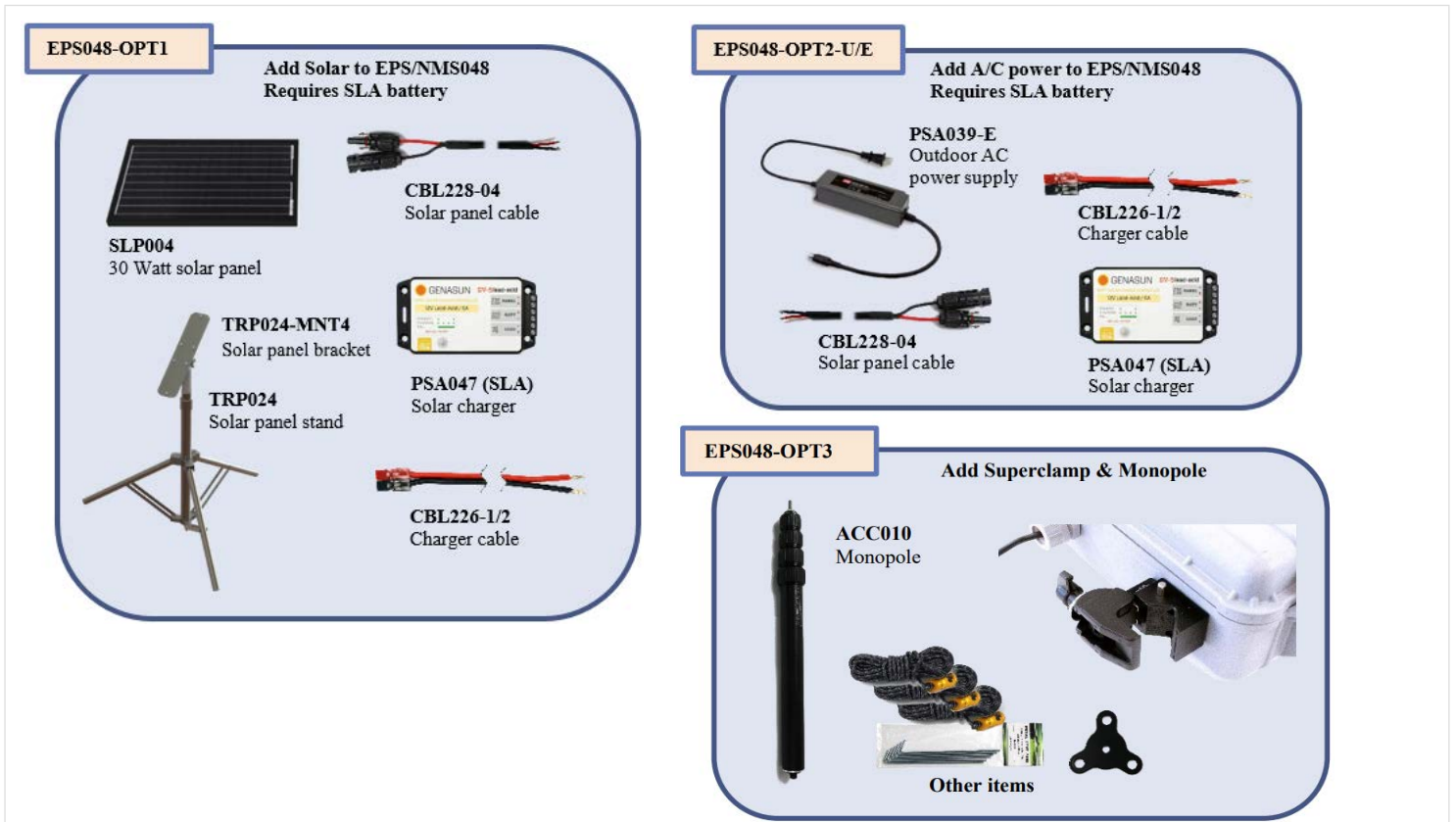

Item Description and Contents

<p>EPS048-OPT1: Solar Kit for SLA Battery Solar Charging Kit with Solar Panel; Equipment to charge the NMS system via solar power in the field.</p>	<ul style="list-style-type: none"> • SLP004 30 Watt Solar Panel • TRP024 Solar Panel Stand • TRP024-MNT4 Solar Panel Bracket • CBL226-1/2 Solar Charging Cable • CBL228-04 Solar Panel Cable • PSA047 Solar Charge Controller for SLA
<p>EPS048-OPT2-U/E: A/C power for SLA Battery Power Charging Kit requires the EPS048-SLA. This kit adds A/C power and charging for the EPS/NMS048 and requires the SLA Battery. The U is for power plug intended for North America. The E is for a European style power plug.</p>	<ul style="list-style-type: none"> • PSA039 U/E Outdoor A/C Power Supply • CBL226-1/2 Charger Cable • CBL228-04 Panel Cable • PSA047 Charge Controller for SLA
<p>EPS048-OPT3: Superclamp and Monopole. The monopole connected to the side of the case provides stable mount for microphone and preamp housed in the EPS2116 outdoor protection, not included.</p>	<ul style="list-style-type: none"> • Monopole (ACC010) with guy wires and stakes • Case-mounted Base Superclamp • Carry Bag

TABLE 7.5 Individual Optional Accessories for NMS048

Individual Accessories for Outdoor Noise Monitoring
<ol style="list-style-type: none">1. Class I Acoustic Calibrator (CAL200)2. Tripod, aluminum (TRP025)

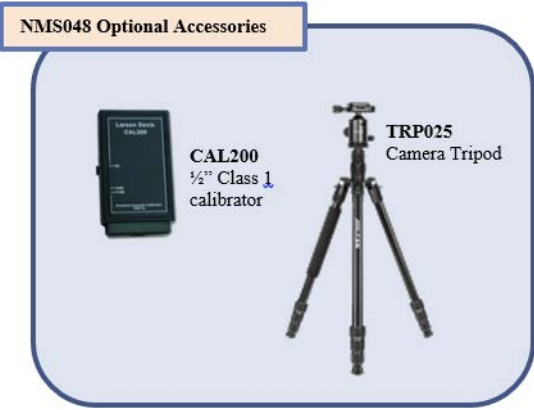

The image shows two optional accessories for the NMS048 system. On the left is a black rectangular device labeled 'CAL200 1/2" Class 1 calibrator'. On the right is a black tripod labeled 'TRP025 Camera Tripod'. Both items are enclosed in a light blue rounded rectangle with a blue border. Above the rectangle is a yellow callout box with the text 'NMS048 Optional Accessories'.

7.2 EPS/NMS048 Configuration Guide

For the latest information visit the Larson Davis NMS048 website:

[Noise Monitoring System Page](#)

[Configuration Guide](#)

Use the following diagram to determine which components you need and how to connect up the power for the meter.

The system assembly was completed as much as possible at the factory. This section assists you to prepare the system for deployment to the measurement site.

7.3 Assembling Travel Packs

Assemble all components in the recommended 3 travel packs. See *Figure 7-1*.

FIGURE 7-1 NMS048 Deployment Travel Packs



FIGURE 7-2 Configuration Drawing

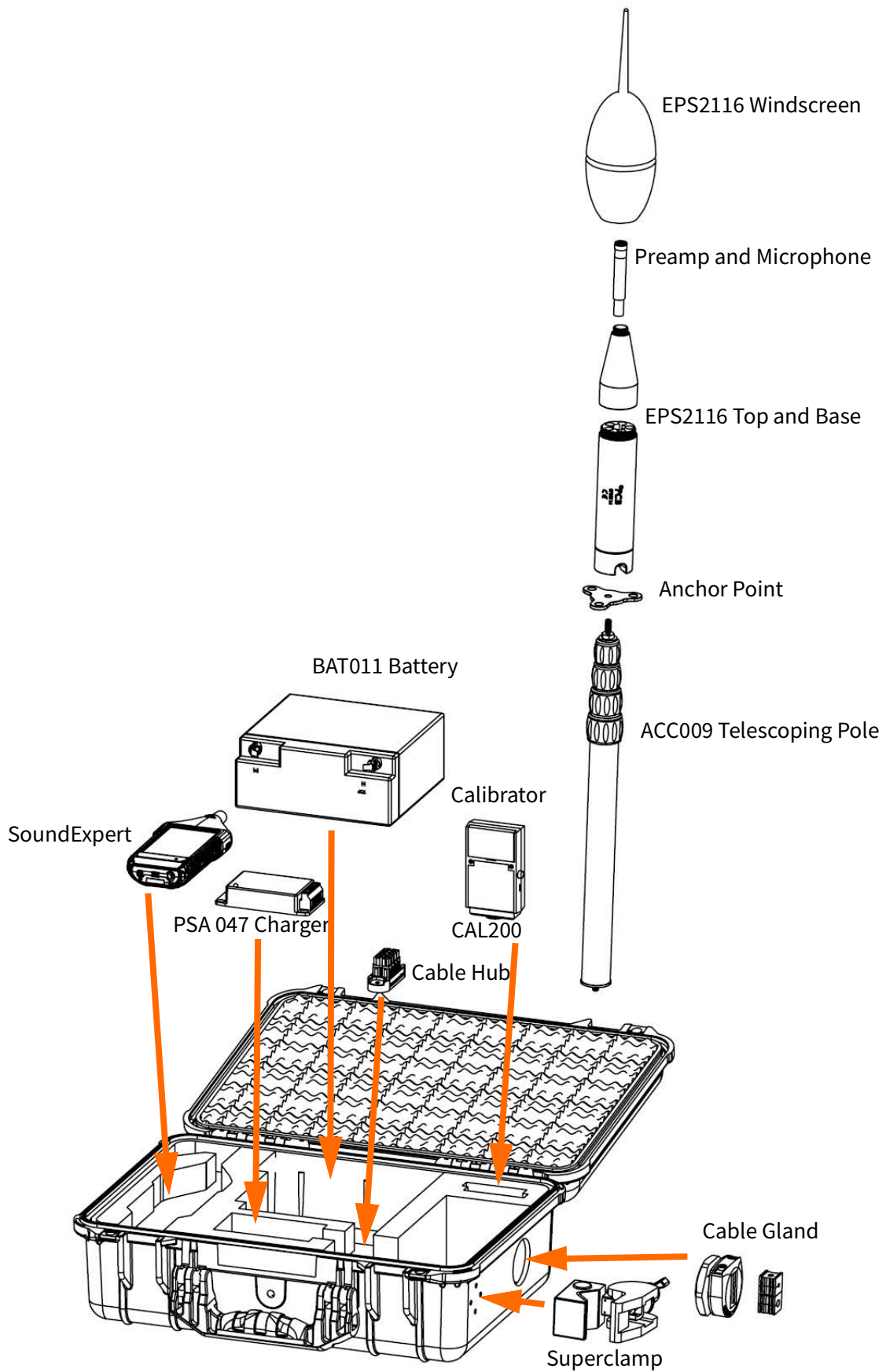

7.3.2 Assemble EPS2116

The meter, power cables, BAT009 Battery, PSA047 Charger, and CAL200 Calibrator fit nicely in the EPS048 case. The preamp cable connects to the meter and extends out through the gland through the EPS2116 protective base and top to the PRM821/721 preamp and microphone with the windscreen and bird spike at the top of the ACC009 telescoping monopole held by the superclamp. Use the anchor points to secure the pole to the ground with the provided guy lines and stakes. Ensure desiccants are installed properly with the EPS2116 for humidity control.

LEARN MORE To learn more about the assembly of the EPS2116 refer to the EPS2116 Reference Manual (IEPS2116.01).

FIGURE 7-3 SoundExpert 821/721 NMS System Wiring Overview

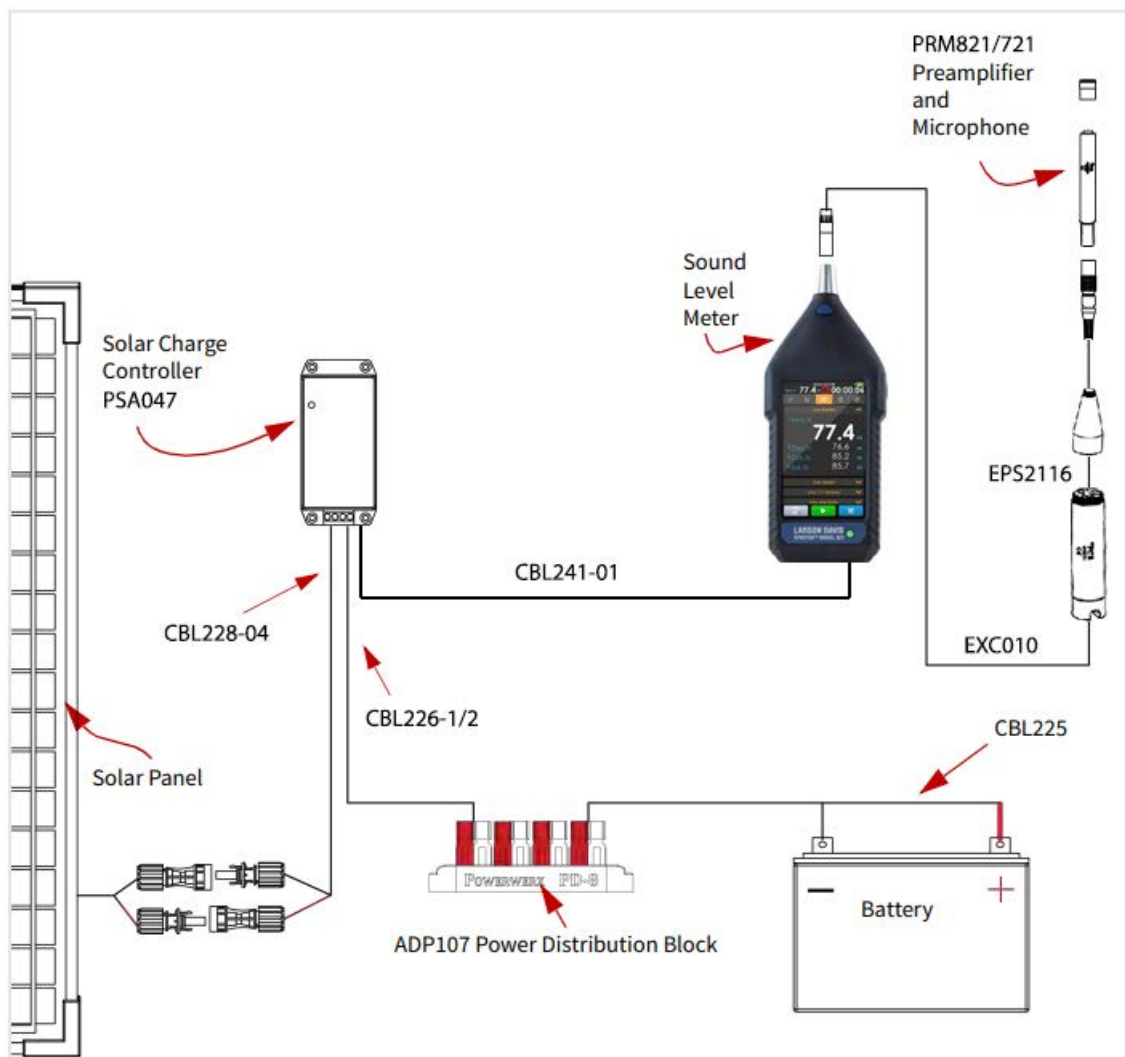

FIGURE 7-4 Example of Assembled System



7.3.3 The assembly of the EPS48-OPT1



Mount the plate ensuring that it is placed inside of the back edges of the solar panel by tightening the thumb screws. Extend the legs of the tripod and then place the mount on the tripod and tighten the large black thumbscrew to hold the mount on the tripod. Set the angle to 45 degrees.



Place sandbags and/or U-shaped ground stakes to protect the setup from wind. Once positioned connect the cables as denoted in *Figure 7-3 SoundExpert 821/721 NMS System Wiring Overview*. The tripod should be placed in such a way as to not influence your measurement.

7.4 Hardware and Firmware for Noise Monitoring Systems

In this section:

- [7.4.1 Firmware Options](#)
- [7.4.2 Hardware Options and Accessories](#)

7.4.1 Firmware Options

The following upgrades/options are available to purchase from Larson Davis or via your LD representative.

Optional Firmware Packages	
Dosimetry (X21-DOS)	<i>Description:</i> Noise exposure measurements and metrics compliant with a variety of occupational safety standards.
Octave Band Analysis (X21-OB3)	<i>Description:</i> Simultaneous, real-time 1/1 & 1/3 Octave Frequency Analysis for the range of 6.3 Hz to 20 kHz. Compliant with IEC 61260:2014 Class 1 and ANSI S1.11-2014 Class 1 standards.
No Bluetooth (X21-NB)	<i>Description:</i> Disables Bluetooth connectivity while the option is enabled. <i>Available For:</i> All models
Agency Approval (821ENV-LNE/PTB)	<i>Description:</i> When installed and enabled, the Agency Approval firmware enables you to produce measurement data that is approved by the following agencies: LNE or PTB. When in use, the “LNE” or “PTB” icon displays in the status bar <i>Available For:</i> SoundExpert 821 Models only

7.4.2 Hardware Options and Accessories

The SoundExpert 721/821 can be used for a wide range of acoustic measurement applications. The following table contains only a few examples of adaptive hardware options, such as microphones, preamplifiers, software, power supplies, tripods, calibrators, sensors, protective cases, adapters, and cables. For a complete listing of standard and system accessories, see the [Ordering page at Larson Davis.com](#).

TABLE 7.6 Options Details

Description	Options Available
Outdoor Noise Monitoring Options	EPS048-OPT1 Add solar panel and charge controller to EPS048. Includes SLP004, CBL226-1/2, CBL228-03, TRP024 & PSA047 for SLA battery. Does not include required BAT011 SLA battery
	EPS048-OPT2-U/E: Add MAINS power with US or European plug to EPS048. Includes PSA039-E, CBL226-1/2, CBL228-03 & PSA047. Requires BAT011 SLA battery, not included
	EPS048-OPT3: Vertical pole for sound-monitoring attached to case for outdoor, long or short-term, unattended sound monitoring
	NMS/EPS048-SLA or -SLA-S: Solar-powered noise monitoring system for outdoor, long or short-term, unattended sound monitoring. Comes with Weather-proof Enclosure for Microphone and Preamplifier (EPS2116), SoundExpert weather-proof case, and power supply (PSA040)
Battery Power Options	EPS048-SLA: SoundExpert weather-proof case with 12 V SLA battery, 21 A h
	EPS048-ALK: SoundExpert weather-proof case with D-cell battery compartment and connections
Communication Options	DVX017: Bluetooth USB Adapter for PC
Equivalent Electrical Impedance Adapter Options	Choose one of the following adapters in place of the microphone when making very high impedance measurements. The adapter acts as a series capacitor with the same capacitance as the microphone it replaces. If you're making a square wave pulse measurement, include a 75 kHz, low pass, T-filter with the adapter.
	ADP090 12 pF, BNC Input Adapter for 1/2-inch, 12 pF microphone equivalent
	ADP092 BNC In-Line, Low Pass Filter, 75kHz

Appendix **A** Technical Specifications



In this module:

A.1	Instrument Hardware Specifications	A-2
A.2	Instrument Performance Specifications	A-20
A.3	Model PRM721 and PRM821 Specifications	A-26
A.4	Octave Band Analysis Specifications	A-27
A.5	Directional Response	A-31

Unless otherwise noted, these specifications apply to the Larson Davis SoundExpert 721/821 used with a microphone/preamplifier (377B02 and PRM821, or 375A04 and PRM721), and preamplifier extension cable up to 200 feet (60 m); (Use P/N EXCXXX-EXC200).

A.1 Instrument Hardware Specifications

A.1.1 Compliance or Standards Met

SLM Standards	IEC 61672-1:2013 Class 1 (821) and Class 2 (721), Group X ANSI S1.4-2014 Class 1 (821) and Class 2 (721) ANSI S1.43-1997 Type 1 (821) and Type 2 (721) IEC 60651:2001 Type 1 (821) and Type 2 (721) IEC 60684:2000 Type 1 (821) and Type 2 (721)						
Octave Band Filter Standards	ANSI S1.11-2014 Class 1 with Option X21-OB3 IEC 61260-1:2014 Class 1 with Option X21-OB3						
Safety	IEC 61010-1:2010: Safety Requirements for Electrical Equipment for Measurement, Control, and Laboratory Use						
EMC Emission	CISPR 11:2015 with Amend 1 (EN 55011)						
EMC Immunity	EN 61672-1:2013, EN 61000-6-2:2005						
Electrostatic discharge (ESD) Immunity	IEC 61000-4-2:2008, ± 4kV contact discharges and ± 8 kV air discharges.						
Other Standards	Test results and certificates compliant with ISO 17025 FCC Part 15, Subpart B						
	<table border="1"> <tr> <td></td> <td>CE-mark indicates compliance with the EMC, Low Voltage, and RoHS Directives</td> </tr> <tr> <td></td> <td>WEEE mark indicates compliance with the EU WEEE Directive</td> </tr> <tr> <td></td> <td>UKCA mark indicates conformity with the applicable requirements for products sold within Great Britain</td> </tr> </table>		CE-mark indicates compliance with the EMC, Low Voltage, and RoHS Directives		WEEE mark indicates compliance with the EU WEEE Directive		UKCA mark indicates conformity with the applicable requirements for products sold within Great Britain
	CE-mark indicates compliance with the EMC, Low Voltage, and RoHS Directives						
	WEEE mark indicates compliance with the EU WEEE Directive						
	UKCA mark indicates conformity with the applicable requirements for products sold within Great Britain						

A.1.2 Hardware Physical Specifications

Sound Level Meter Physical Specifications

FIGURE A-1 Meter Dimensions

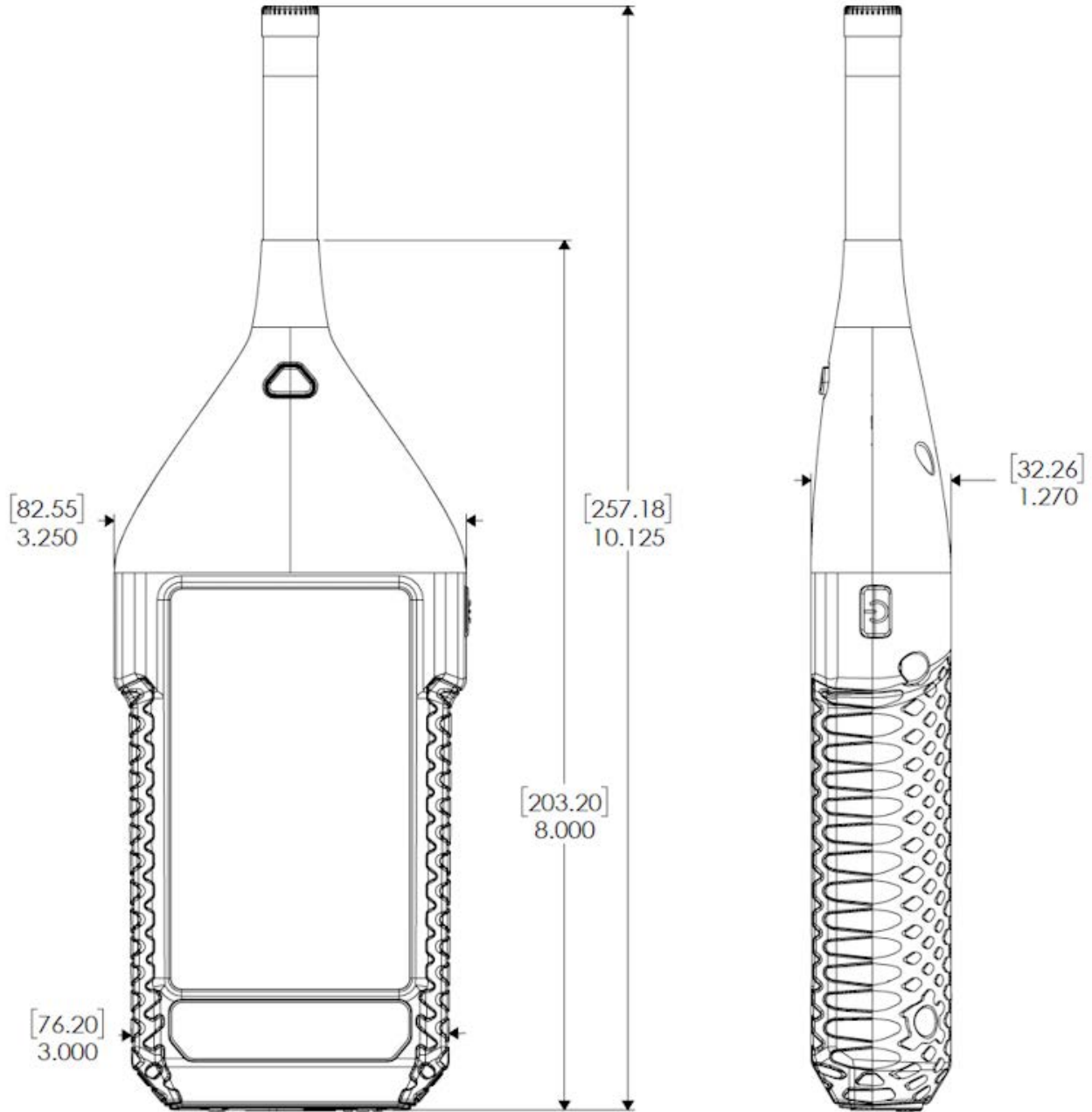

<p>Dimensions:</p>	<p>260.4 x 82.6 x 32.3mm (10.25 x 3.25 x 1.27 inches) including microphone and preamplifier 203.2 x 82.6 x 32.3 mm (8.0 x 3.25 x 1.27 inches) instrument body only</p>
<p>Weight:</p>	<p>382.5 g (13.5 oz) including batteries, preamplifier, and microphone 342 g (12.1 oz) instrument body only</p>

FIGURE A-2 Meter Mount Dimensions

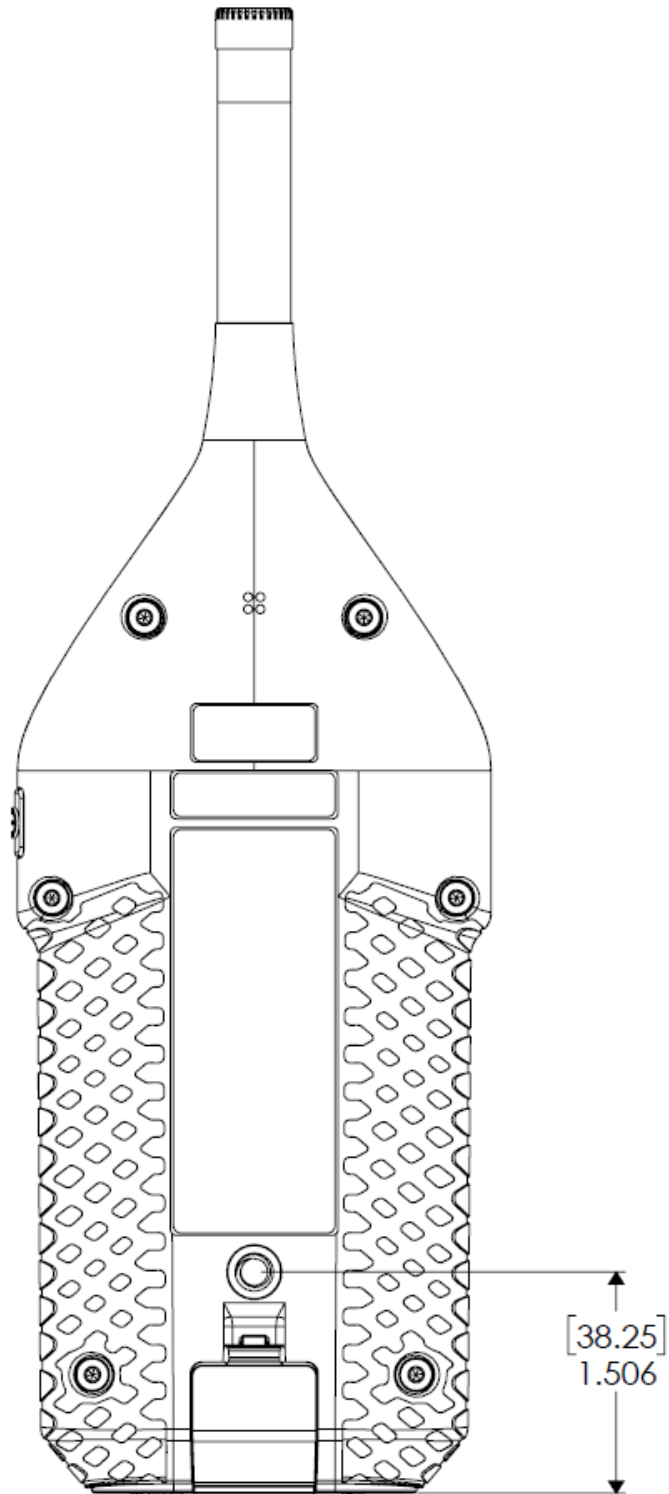

Microphone & Input Physical Specifications

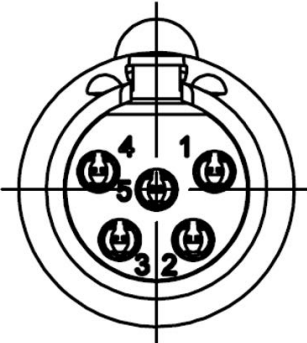
Supplied Microphone & Preamplifier	Class 1: Model 377B02 microphone with Model PRM821 preamplifier Class 2: Model 375A04 microphone with model PRM721 preamplifier
Typical Sensitivity	50 mV/Pa (± 1.5 dB) corresponding to -26 dB re. 1 V/Pa
Frequency Response	3 Hz to 20 kHz (± 2 dB)
Microphone Connection	Thread for 1/2-inch (WS-2) microphone
Microphone Polarization Voltage	0 V; No polarization is provided; Use pre-polarized microphone
Preamplifier Connection	Latching 5-pin circular connector for PRM721/PRM821  <p>Pinout: 1: Ground 2: Signal 3: Power 4: Sense 5: NC</p>
Preamplifier Power Supply	+36 V
Extension Cables	A preamplifier extension cable may be connected between the meter and the preamplifier/microphone with no degradation for lengths up to 200 feet (61 m)
Full Scale Input	± 14.14 V _{peak} , ± 10 V _{rms} AC
Sample Rate	48000 sps

Microphone Preamplifier Physical Specifications

Typical Preamplifier Attenuation	0.08 dB
---	---------

A.1.3 Typical Electrical Frequency Response

FIGURE A-3 Typical Electrical Z-Weight Low Frequency Response using PRM821 / PRM721

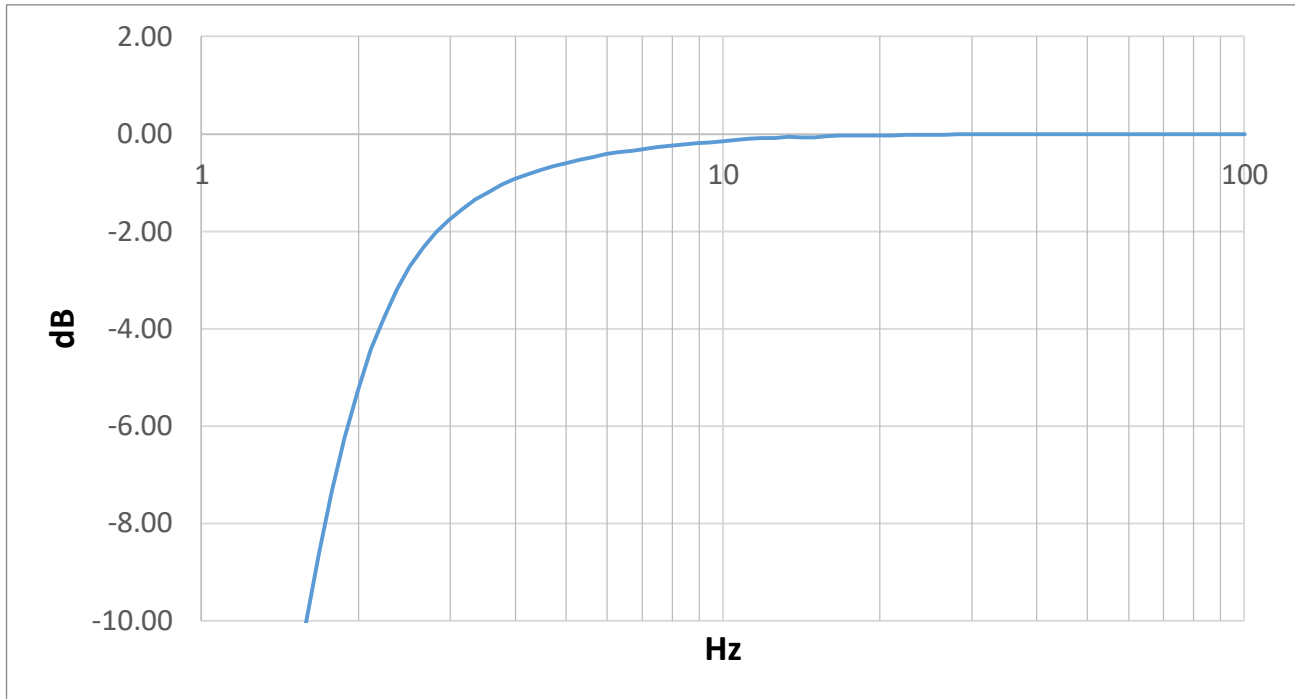

TABLE A.1 Typical Electrical Z-Weight Frequency Response using PRM821 / PRM721

Nominal Frequency (Hz)	Typical Frequency Response (dB)
1	-24.95
2	-5.27
2.5	-2.72
3	-1.54
4	-0.93
5	-0.60
6.3	-0.38
8	-0.24
10	-0.15
12.5	-0.09
16	-0.04
20	-0.03
25	-0.02
32	0.00
40	0.00

TABLE A.1 Typical Electrical Z-Weight Frequency Response using PRM821 / PRM721 (Continued)

Nominal Frequency (Hz)	Typical Frequency Response (dB)
50	0.00
63	0.00
80	0.00
100	0.00
250	0.00
315	0.00
400	0.00
500	0.00
630	0.00
800	0.00
1000	0.00
1250	0.00
1600	0.00
2000	0.00
2500	0.00
3150	0.00
4000	0.00
5000	0.00
6300	0.00
8000	0.00
10000	0.00
12500	0.00
16000	0.00
20000	0.00

A.1.4 Microphone Model 377B02 Filter Response and Corrections

Frequency response correction filters are available for each sound field/microphone type and for environmental protection accessories. Note: “RI” indicates “Random Incidence” and “FF” indicates “Free Field.” The default setting for this instrument is “FF:FF,” which provides the most accurate free-field response for this instrument with or without the WS001 windscreen.

Figure A-4 allows for comparison of provided filter correction values. See the table footnotes for application instructions. Figure A-5 through Figure A-11 describe each filter in detail.

FIGURE A-4 Filter Responses in Comparison

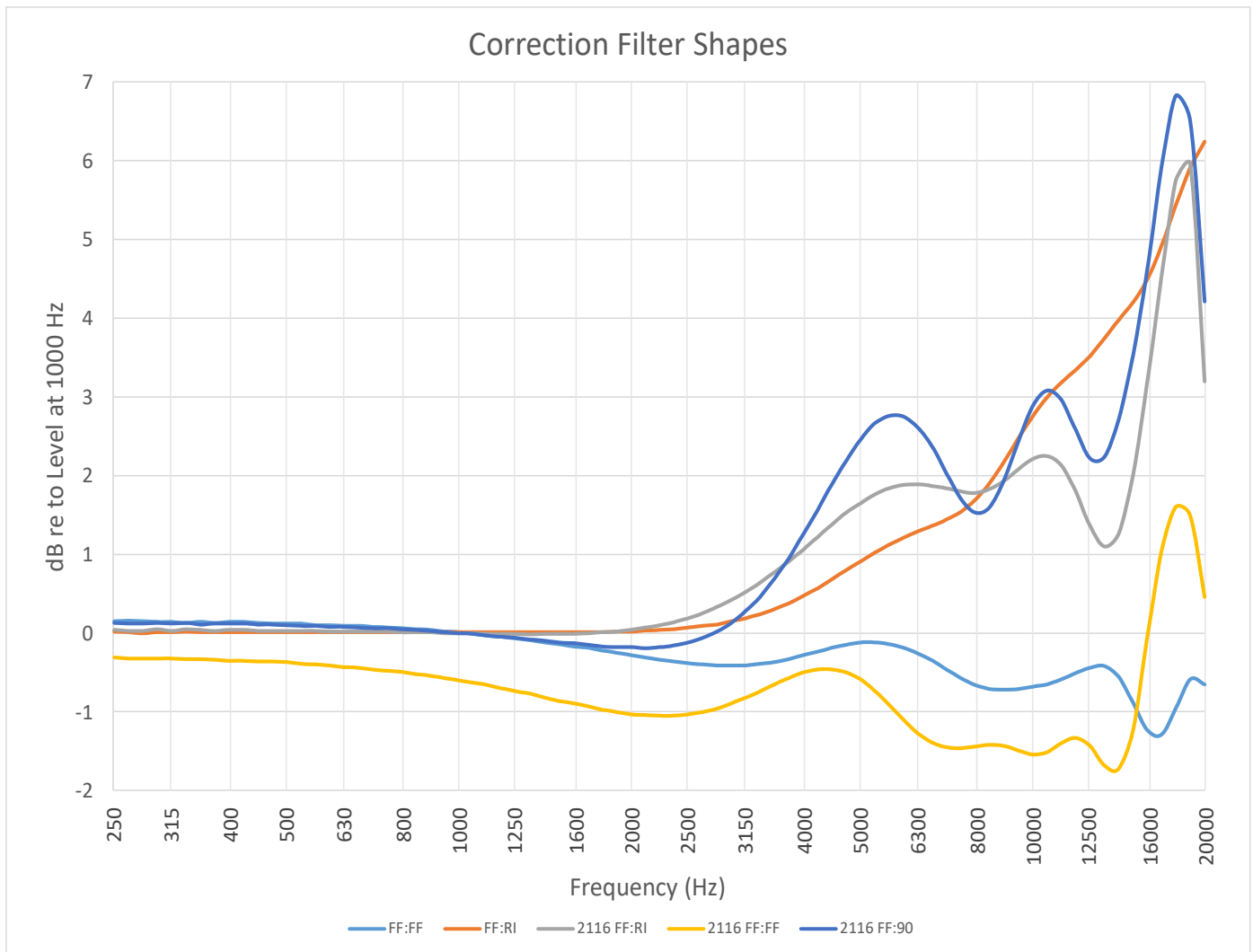

TABLE A.2 Correction Filter Shapes

Frequency	FF:FF	FF:RI	2116 FF:RI	2116 FF:FF	2116 FF:90
250	0.15	0.02	0.04	-0.31	0.13
315	0.14	0.01	0.03	-0.32	0.12
400	0.14	0.01	0.04	-0.35	0.12
500	0.12	0.01	0.03	-0.37	0.1
630	0.09	0.01	0.02	-0.43	0.08
800	0.06	0.01	0.01	-0.49	0.05

TABLE A.2 Correction Filter Shapes (Continued)

Frequency	FF:FF	FF:RI	2116 FF:RI	2116 FF:FF	2116 FF:90
1000	0.01	0.01	0	-0.6	0
1250	-0.07	0.01	-0.01	-0.74	-0.06
1600	-0.17	0.01	-0.01	-0.89	-0.13
2000	-0.28	0.02	0.04	-1.03	-0.18
2500	-0.38	0.07	0.19	-1.03	-0.12
3150	-0.41	0.19	0.52	-0.82	0.28
4000	-0.28	0.47	1.06	-0.5	1.25
5000	-0.12	0.91	1.65	-0.59	2.46
6300	-0.26	1.29	1.89	-1.27	2.61
8000	-0.66	1.69	1.78	-1.44	1.53
10000	-0.68	2.75	2.21	-1.54	2.88
12500	-0.44	3.52	1.36	-1.43	2.22
16000	-1.23	4.49	3.18	-0.06	4.61

TABLE A.3 Model 821 with 377B02/PRM821

Frequency (Hz)	From B&K 4226 Calibrator		From Electrostatic Actuator		Expanded Uncertainty of Corrections (k=2) (dB)
	0° Free Field Corrections 821 - No WS ¹ (dB re 1 kHz)	0° Free Field Corrections 821 - With WS ¹ (dB re 1 kHz)	0° Free Field Corrections 821 - No WS ¹ (dB re 1 kHz)	0° Free Field Corrections 821 - With WS ¹ (dB re 1 kHz)	
31.5	0.01	-0.06	0.07	0.00	0.25
63	-0.06	-0.13	0.02	-0.05	0.25
125	-0.03	-0.10	0.01	-0.06	0.25
250	-0.02	-0.10	0.01	-0.07	0.25
500	0.03	0.03	0.03	0.03	0.25
1000	0.00	0.10	0.00	0.10	0.25
2000	0.49	0.99	0.47	0.97	0.25
4000	1.01	1.11	0.87	0.97	0.25
8000	3.16	2.84	3.63	3.31	0.35
12500	5.86	4.79	7.26	6.19	0.50
16000	7.16	5.66	8.61	7.11	0.50

1. Add values from these columns to levels read on the SLM to correct for the 0° free-field level at that frequency.

Note: These values were obtained at the following reference conditions: -40° C, 50% RH, 40 k/Pa

Microphone Filter Response Details - Model 377B02

In this section:

- [Figure A-5 Model 821 Free-Field Response With 377B02](#)
- [Figure A-6 Model 821 Free-Field Response With 377B02 and Windscreen \(WS001\)](#)
- [Figure A-7 Model 821 Random Response With 377B02](#)
- [Figure A-8 Model 821 Random Response With 377B02 and Windscreen \(WS001\)](#)
- [Figure A-9 EPS2116 Free-Field Response](#)
- [Figure A-10 EPS2116 90 Degree Response](#)
- [Figure A-11 EPS2116 Random Response](#)

FIGURE A-5 Model 821 Free-Field Response With 377B02

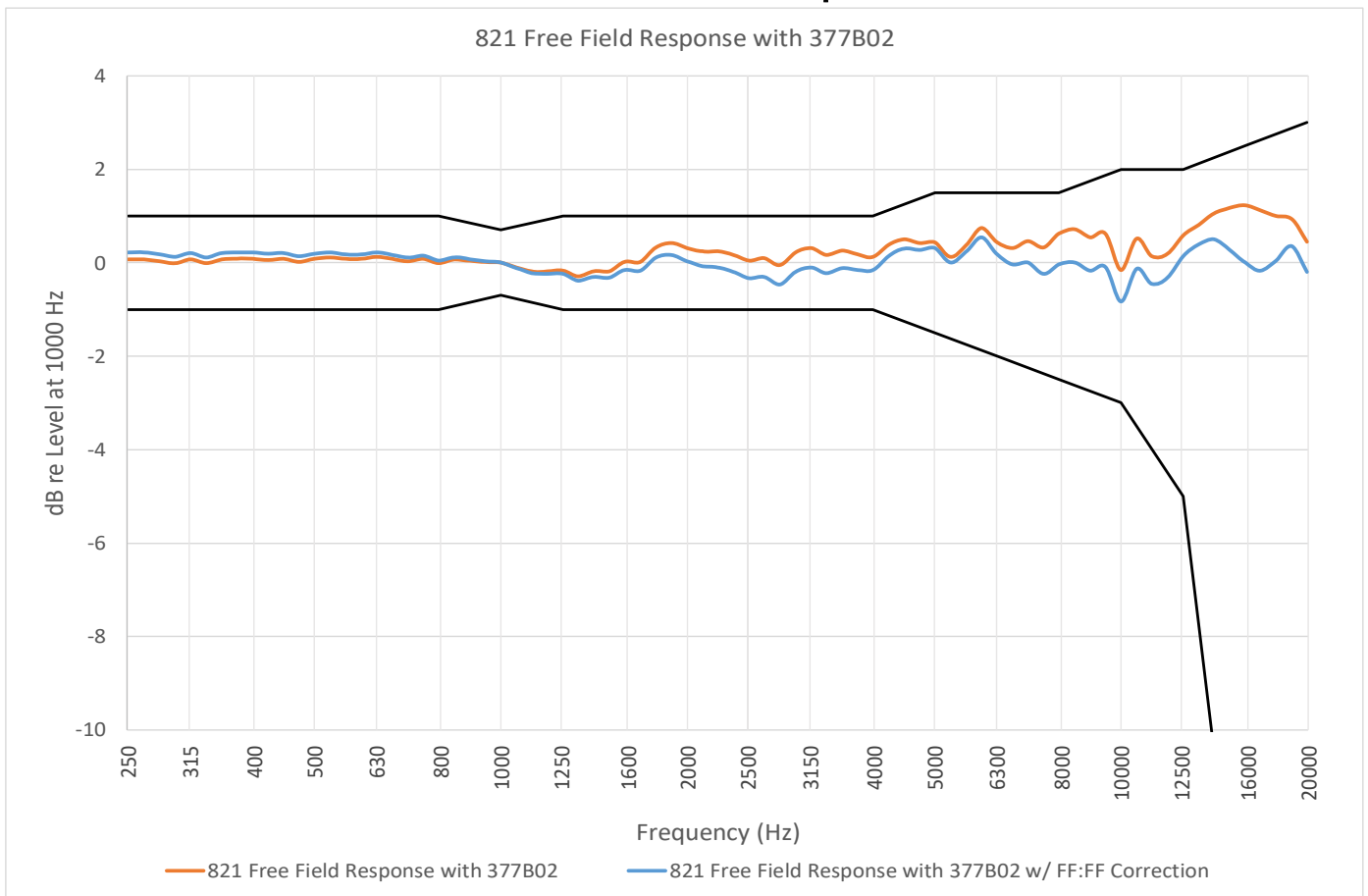

FIGURE A-6 Model 821 Free-Field Response With 377B02 and Windscreen (WS001)

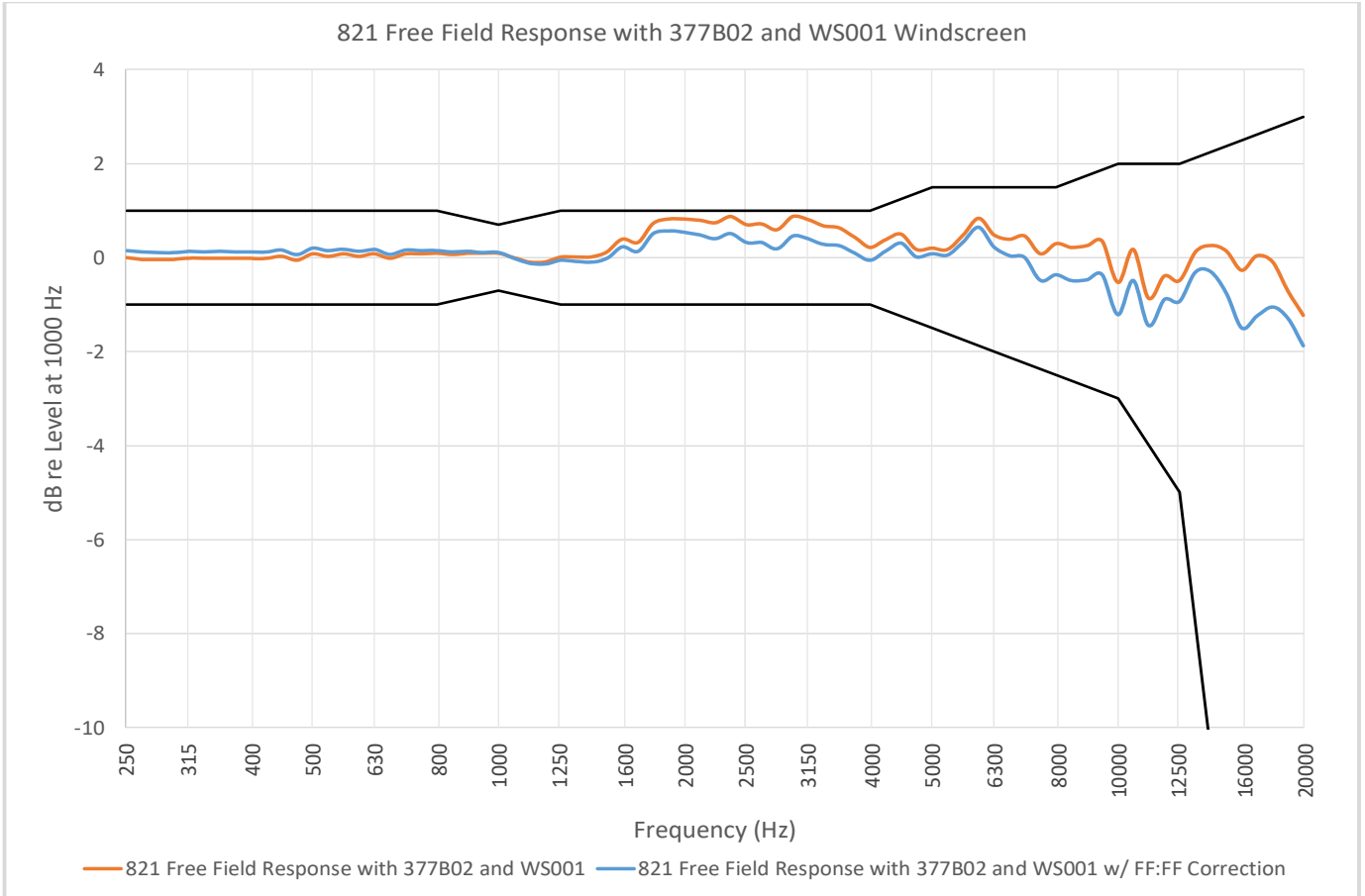

FIGURE A-7 Model 821 Random Response With 377B02

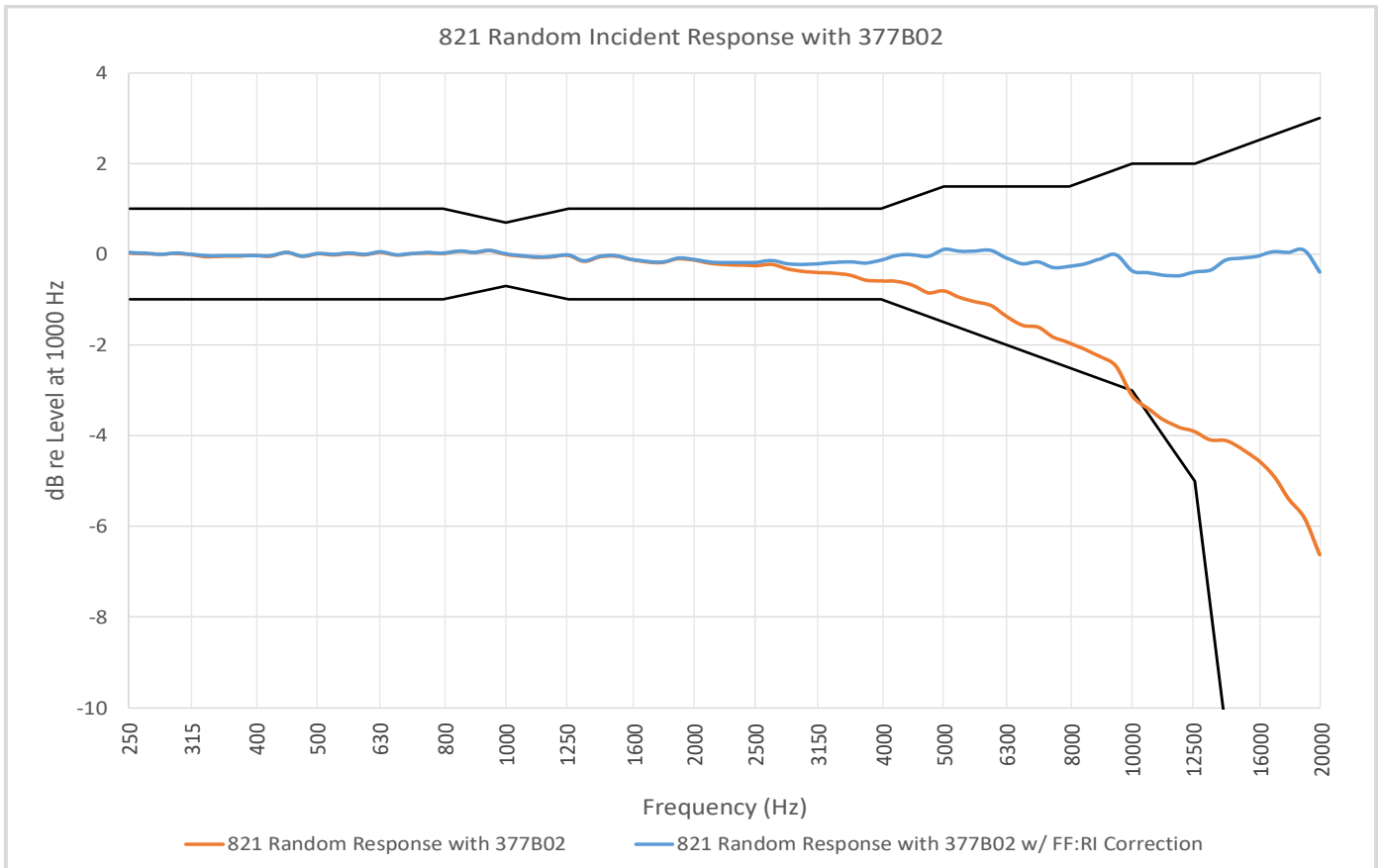

FIGURE A-8 Model 821 Random Response With 377B02 and Windscreen (WS001)

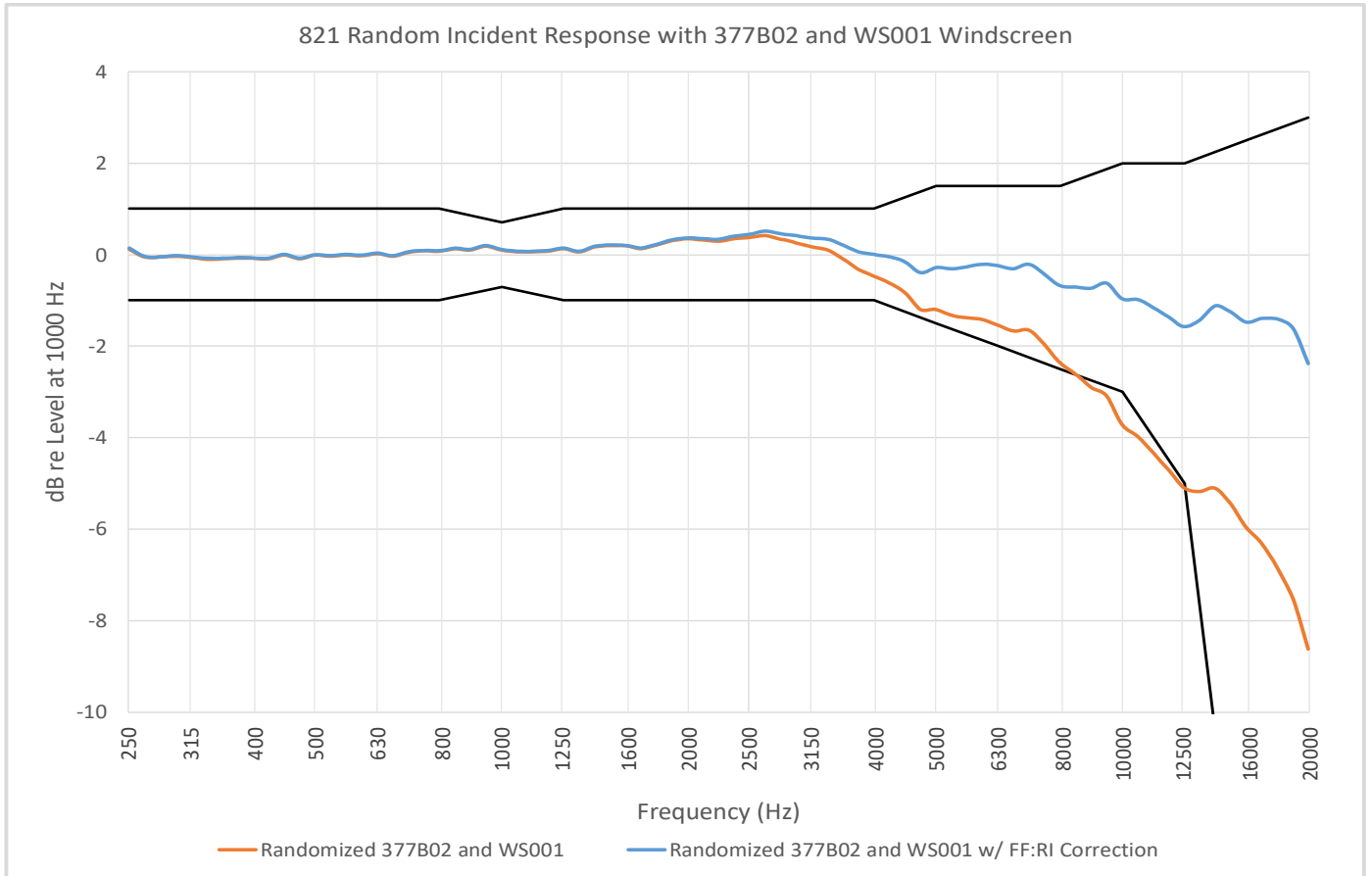

FIGURE A-9 EPS2116 Free-Field Response

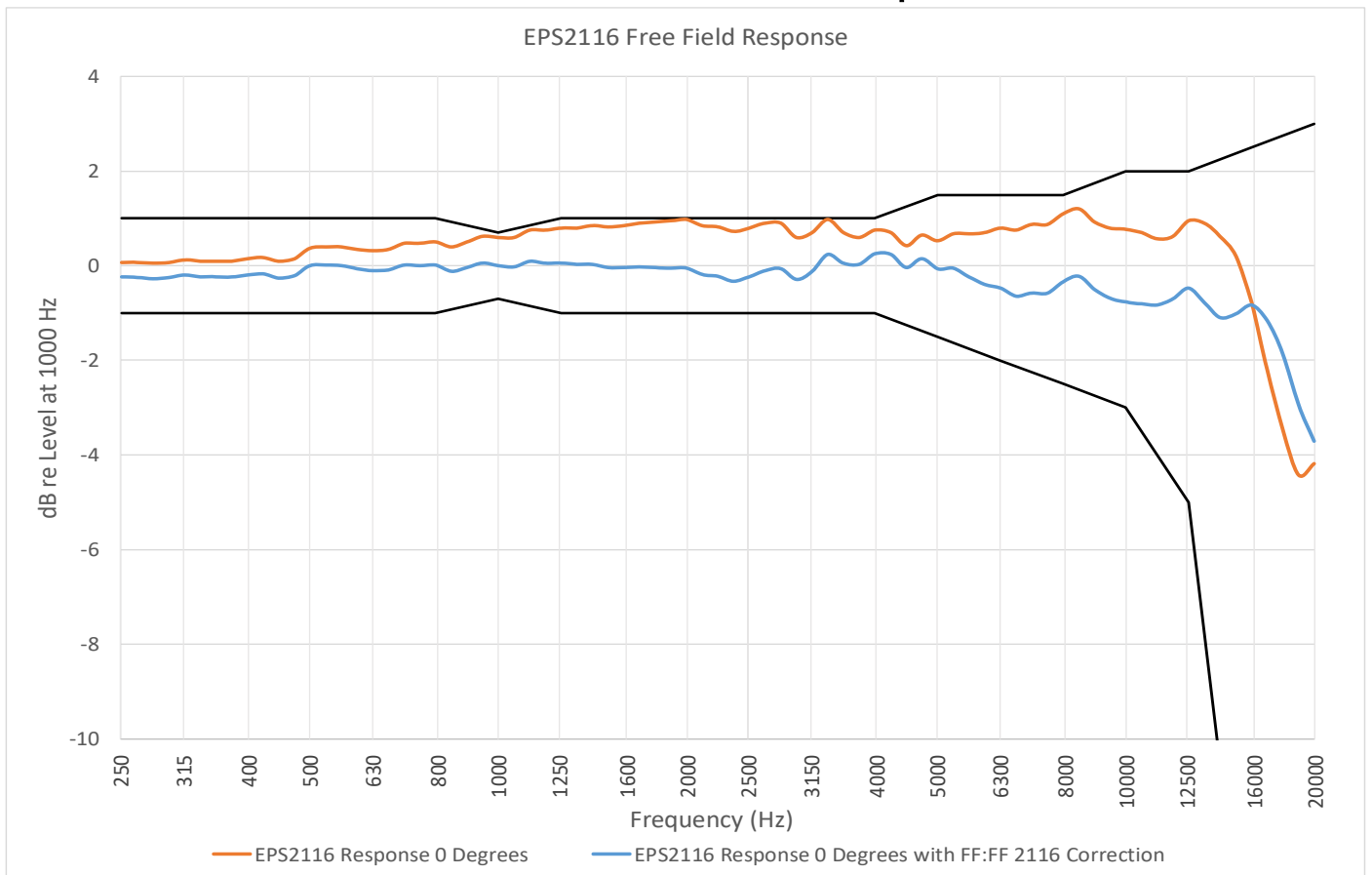

FIGURE A-10 EPS2116 90 Degree Response

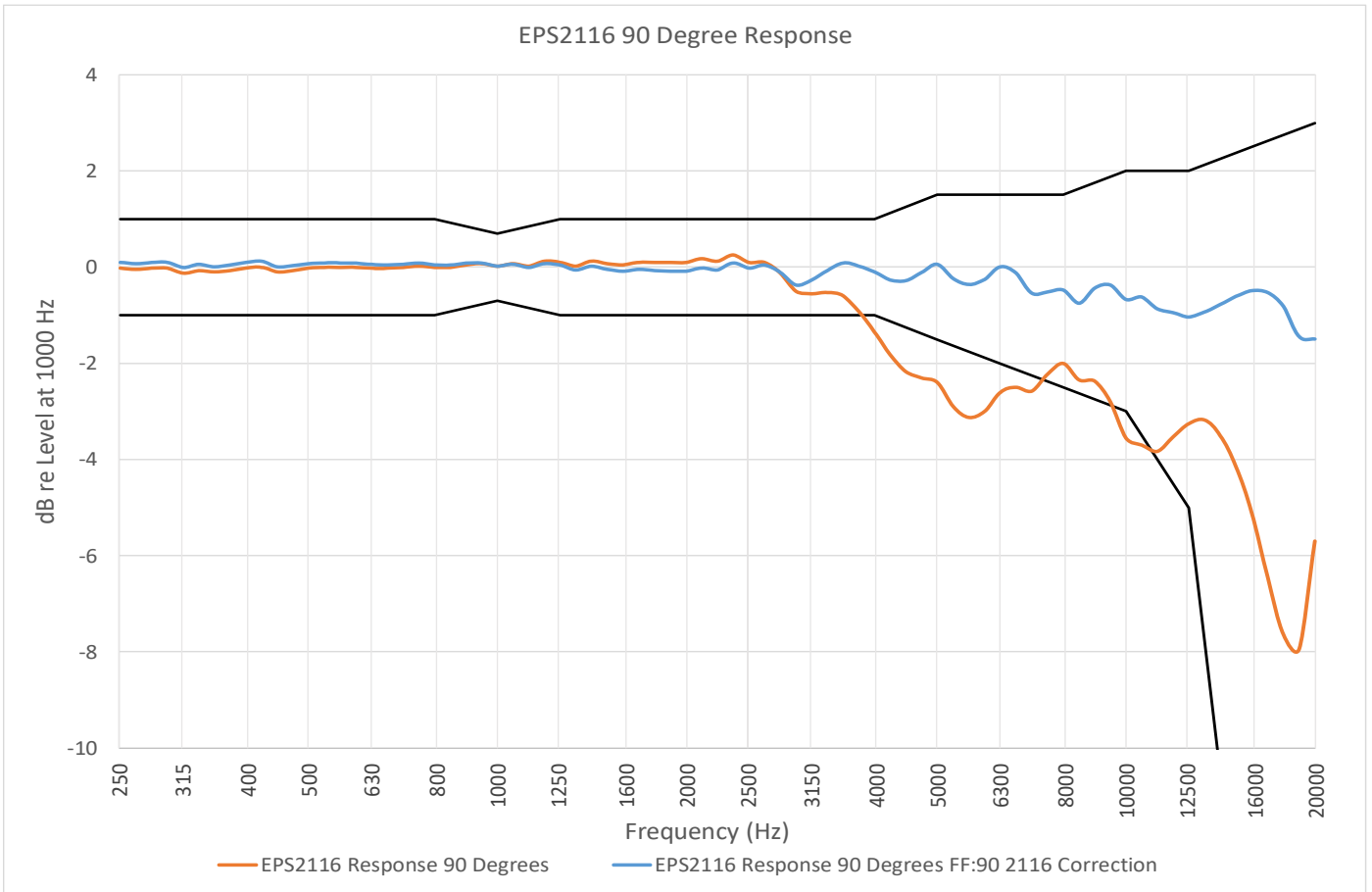
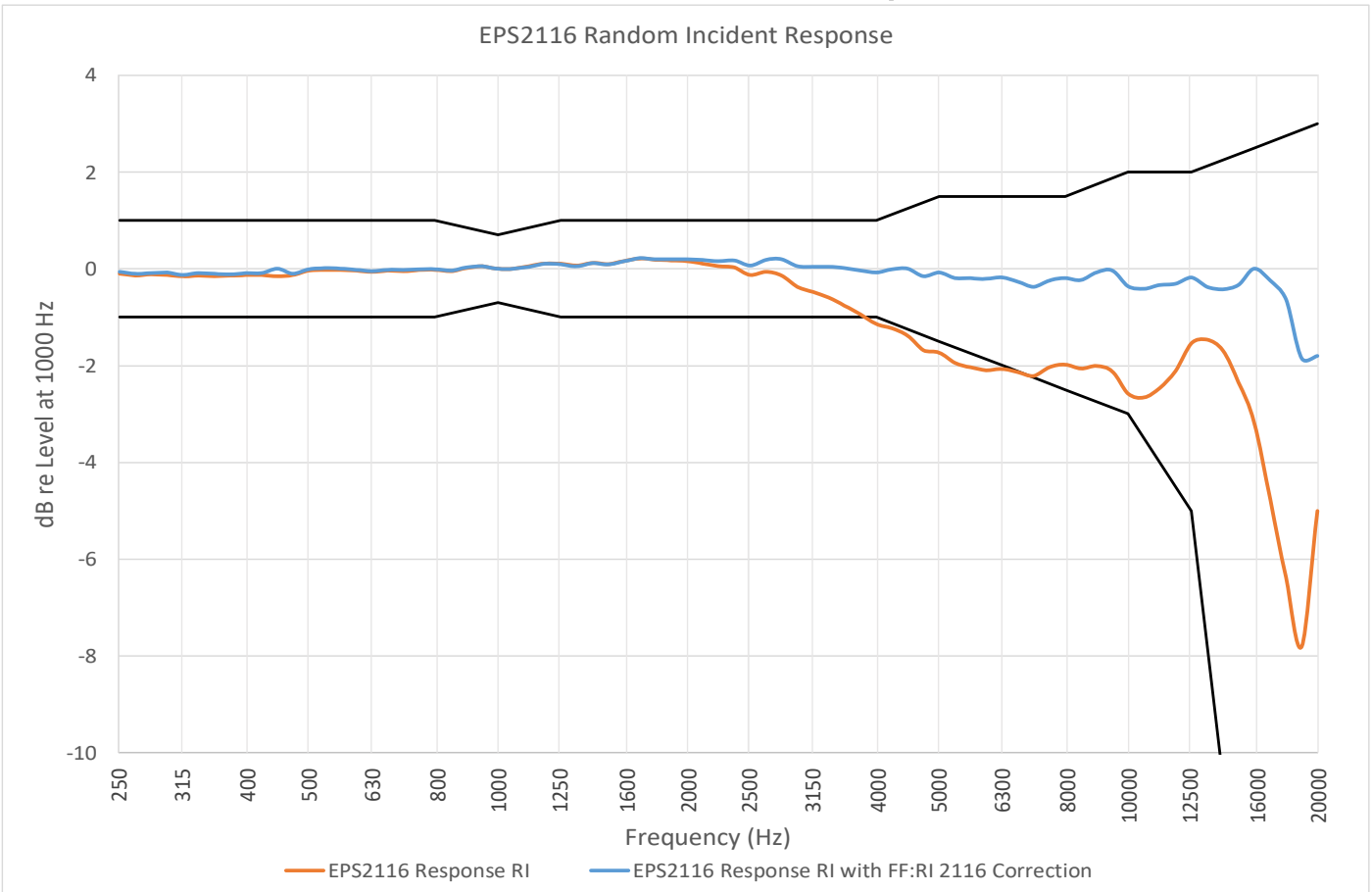

FIGURE A-11 EPS2116 Random Response



A.1.5 Microphone Model 375A04 Filter Response and Corrections

Frequency responses and correction filters for the Model 375A04 microphone are the same as those for the Model 377B02 microphone shown in [A.1.4 Microphone Model 377B02 Filter Response and Corrections](#).

A.1.6 Hardware Interface Specifications

Status Indicator	Tri-color LED Status Light blinks approximately every two seconds when enabled: <ul style="list-style-type: none">● Green = Measurement Running● Yellow = PausedWhite = Stopped● Red = Power button pressed LED Status Light may be disabled. See section 5.4 Troubleshooting the 721 or 821
Display	TFT display: 4.3-inch, 480 x 800 RGB; Updates once per second
Screen Lock	Interface may be locked and unlocked. See section 5.1 Utilizing the Meter Lock
Languages	English, French, Italian, Spanish, Portuguese

A.1.7 USB Client Interface Specifications

Client Interface Type	USB 2.0 High-Speed, Type-C connector
Power Draw	≤ 2 A from PC, USB Hub, or portable power supply (PSA045)
Supported Hosts	PC with G4 LD Utility software PC with custom software using SWW-G4-SDK or SWW-G4-WIN

A.1.8 Bluetooth™ Low Energy Interface

Interface Type	BLE 4.1
Supported Hosts	Android™ ¹ and iOS™ devices via LD Atlas app; PC via G4 LD Utility software

1. The Bluetooth wordmark is a registered trademark of Bluetooth SIG, Inc. in the United States and in other countries. Android is a registered trademark of Google, LLC. in the U.S. and in other countries. IOS is a registered trademark of Cisco Systems and licensed to Apple, Inc. in the U.S. and in other countries.

A.1.9 AC/DC Output Specifications

Connector	3.5 mm TRRS connector Pinout: Tip: DC Out Ring 1: AC Out Ring 2: Ground Sleeve: Connector Detect (Tie to Ground)
AC Output Voltage	Preamp Output: +18/-14 V _{peak} Max, +12.7/-10 V _{rms}
AC Output Impedance	1 k Ω 1,000 pF
DC Output Voltage	10 mV/dB, +2.5 V Max, \pm 1 mV (0.1 dB) at room temperature
DC Output Impedance	1 k Ω 1,000 pF
Recommended Load Impedances	50 Ω - 10 M Ω

A.1.10 Wireless Charger Specifications

Charger Type	Qi™ WPC-compatible receiver
Required Power	5 W Minimum

A.1.11 External DC Power Supply Specifications

Voltage	+6 V to +24 V
Required Power	<p>10 W minimum for fast charge; 2.5 W minimum for unit without charging with screen on 1.0 W minimum for unit without charging and screen off</p> <p>Typical power draw from *12V supply:</p> <ul style="list-style-type: none">• Base power with screen off: 720mW• Screen on 100% brightness add 1500 mW• Screen on 50% brightness add 1200 mW• 1/1 or 1/3 OBA add 60 mW• 100ms Time History add 165 mW <p>*Total power draw is estimated by summing the base power with the additional powers from the named states. These values are estimated with a 12V input supply. Differing supply voltages can cause further change.</p>

A.1.12 Battery Power Specifications

Battery Type	Internal Lithium-Ion batteries
Typical Operating Time	<p>Display Off 40 hours (Typical power draw 0.5W) 30 hours with 100ms Time history (Typical power draw 0.65W)</p> <p>Display On 50% brightness 15 hours (Typical power draw 1.6W) 12 hours with 100ms Time history (Typical power draw 2W)</p>
Charge Time (at room temp)	<p>Fast charge: 2.75 hours to 50% USB or External Power: up to 8 hours Qi Wireless Charger: up to 14 hours</p>
Charge Priority (highest to lowest)	<p>1: USB 2: Qi Wireless Charger 3: External DC Power</p>
Self Discharge	<p>Batteries will self discharge 10-15% per month when the unit is powered off. Charge unit before use after long periods of storage.</p>

A.1.13 Instrument Date and Time Specifications

Drift	Less than 0.5 seconds per 24 hours, -20° C to 50° C (-4° F to 122° F)
Format	ISO8601; hh:mm:ss yyyy-mm-dd; Meter Display also uses dd/mm hh::mm::ss

A.1.14 Data Storage Specifications

Type	Removable microSD card, Class 10 or UHS 1 minimum
Card Size	<p>SDHC Up to 32 GB or SDXC Up to 256 GB, with no limit to the number of files or settings*</p> <p>For SDXC cards or cards not formatted with FAT filesystem, card will need to be formatted in the meter. Any existing data on the card will be lost after format. See 5.5 Troubleshooting File Storage for instructions on reformatting the microSD card.</p> <p>* System performance may decrease with large numbers of files, recommended to keep less than 10000 files</p>
Data Stored	<p>Measurement data and settings</p> <p>Maximum Data Usage per 24 hours: 250 MB</p>

A.1.15 Electrostatic Discharge Specifications

This instrument is not adversely affected by electrostatic discharge under normal operating conditions and within normal human static discharge limits of IEC61000-4-2:2008, ± 4 kV contact discharges and ± 8 kV air discharges. Care must be taken when replacing the microphone and preamp, as well as when replacing the microSD card. See **2.1.1 Connecting the Preamp and Microphone** and **5.5 Troubleshooting File Storage** for more details.

A.1.16 Environmental Conditions Specifications

Operating Temperature- External Power¹	-30° to 60° C (-22° F to 140° F)
Operating Temperature- Internal Batteries	Discharge: -20° C to 60° C (-4° F to 140° F) Charge: 0° C to 40° C (-32° F to 104° F)
Storage Environment¹	-30° C to +60° C (-22° F to 140° F) with < 90% humidity
Display Operating Temperature²	Operating: -20° C to +70° C (-4° F to 158° F) Storage: -30° C to +80° C (-22° F to 176° F)

1. When the unit is run for long periods outside of the storage temperature and humidity, the internal battery capacity decreases.
2. The display stops functioning when used outside of the Display Operating temperatures. But it recovers when brought back within the noted temperature range.
3. The sound level meter may be used at static pressures down to 65 kPa. Be sure to perform an acoustic calibration before use in these scenarios where the static pressure is less than 85 kPa.

A.1.17 Mechanical Vibration Effects Recommendations

Mechanical vibration can affect indicated levels at the lower boundary of the measurement range at frequencies within the range of the sound level meter. In order to minimize the effects of mechanical vibration, avoid mounting the sound level meter with the microphone diaphragm perpendicular to the direction of vibration.

A.1.18 Care and Cleaning

The meter can be cleaned using a damp cloth. Do not use bleach or alcohol. For soft surfaces—such as the windscreen and foam in the carry case—spray with a non-bleach disinfectant spray and allow it to dry.

A.1.19 Electromagnetic Compatibility Effects

With the unit in the normal mode of operation, the LAeq sound level of the unit was not affected when exposed to a magnetic field of 80 A/m with a 1 kHz signal at 74 dB. There may be some small effects at low sound levels when exposed to alternating magnetic fields or radio frequency electromagnetic fields

A.1.20 FCC/IC Compliance

Contains **FCC ID: XPYBMD360**

This device complies with part 15 of the FCC rules.

Operation is subject to the following two conditions. (1) This device may not cause harmful interference. (2) This device must accept any interference received, including interference that may cause undesired operation.

Contains **IC transmitter module ID: 8595A-BMD360**

This device complies with Industry Canada license exempt RSS standard(s). Operation is subject to the following two conditions: (1) this device may not cause interference, and (2) this device must accept any interference, including interference that may cause undesired operation of the device.

Le présent appareil est conforme aux CNR d'Industrie Canada applicables aux appareils radio exempts de licence. L'exploitation est autorisée aux deux conditions suivantes: (1) l'appareil ne doit pas produire de brouillage, et (2) l'utilisateur de l'appareil doit accepter tout brouillage radioélectrique subi, même si le brouillage est susceptible d'en compromettre le fonctionnement

A.2 Instrument Performance Specifications

A.2.1 SLM Performance Specifications

		PRM821 with 377B02 (dB SPL)	PRM721 with 375A04 (dB SPL)
Typical Noise Floor¹	A	17	17
	C	18	18
	Z	25	25
Linearity Range²	A	≥116	≥116
		24-140	24-140
	C	≥113	≥113
		27-140	27-140
	Z	≥103	≥103
		37-140	37-140
Peak Range²	A	50-143	50-143
	C	50-143	50-143
	Z	62-143	62-143
SPL Max Level²		≥140	≥140
Peak Max Level²		≥143	≥143

1. Microphone and electrical self-noise included

2. Electrical measurement at 1 kHz. Measurements taken with ADP090 input adapter and PRM821

A.2.2 Measurement System Specifications

In this section:

- **Measurement Properties Specifications**
- **Instantaneous “Live” Metric Specifications**
- **Overall AnyData™ Metric Specifications**
- **Overall Ln Percentile Levels**
- **Overall Community Noise**
- **Overall Overload Metrics**
- **Overall Exceedances**
- **C minus A**
- **Measurement Mode Controls**
- **Measurement History**
- **Overall Community Noise**

- **Industrial Hygiene Specifications**

Measurement Properties Specifications

Integration Time	Minimum, 1 second; Maximum, 30 days
Frequency Weightings	A, C, Z parallel and simultaneous for each time weighting; selected frequency weighting (A, C, or Z) indicated by ω
Time Weightings	Slow, Impulse, Fast, Linear, and Peak; simultaneously for frequency weightings
Peak Rise Time	30 μ s

Instantaneous “Live” Metric Specifications

For display and profile graph. Live metrics are not stored with measurement data.

	Time Weighting	A	C	Z	Units
Linear	--	L_{Aeq}	L_{Ceq}	L_{Zeq}	dB
	Slow	L_{AS}	L_{CS}	L_{ZS}	dB
	Fast	L_{AF}	L_{CF}	L_{ZF}	dB
	Impulse	L_{AI}	L_{CI}	L_{ZI}	dB
Peak	--	L_{Apeak}	L_{Cpeak}	L_{Zpeak}	dB

Overall AnyData™ Metric Specifications

A primary frequency and time weighting is selected by setting for RMS and Peak level to display, all levels are available in an “Any Level” matrix.

	Time Weighting	A	C	Z	Units
Linear	--	L_{Aeq}	L_{Ceq}	L_{Zeq}	dB
	Slow Maximum	L_{ASmax}	L_{CSmax}	L_{ZSmax}	dB
	Slow Minimum	L_{ASmin}	L_{CSmin}	L_{ZSmin}	dB
	Fast Maximum	L_{AFmax}	L_{CFmax}	L_{ZFmax}	dB
	Fast Minimum	L_{AFmin}	L_{CFmin}	L_{ZFmin}	dB
	Impulse	L_{Aeq}	L_{Ceq}	L_{Zeq}	dB
	Impulse Maximum	L_{AImax}	L_{CImax}	L_{ZImax}	dB
	Impulse Minimum	L_{AImin}	L_{CImin}	L_{ZImin}	dB
Peak	--	L_{Apk}	L_{Cpk}	L_{Zpk}	dB

Overall Ln Percentile Levels

Percentages “n1” through “n6” selectable, 0.0 to 100.0%. Statistics are sampled every 10 ms from the selected frequency and time-weighted detector. If a level falls between two dB bins, it will be included in the lower dB bin (for example, levels of 100.19 dB and 100.10 dB will both be counted in the 100.1 dB bin).

	Label	Units
1	$L_{\omega n1}$	dB
2	$L_{\omega n2}$	dB
3	$L_{\omega n3}$	dB
4	$L_{\omega n4}$	dB
5	$L_{\omega n5}$	dB
6	$L_{\omega n6}$	dB

Maximum Level:	140.0	dB
Minimum Level:	20.0	dB
Bin Size:	0.1	dB

Overall Community Noise

Day Evening Night Level	Midnight to Midnight	LDEN
	Daytime portion	LDay (T_{day} to T_{eve})
	Evening-time portion	LEve (T_{eve} to T_{night})
	Nighttime portion	LNight (T_{night} to T_{day})
Day Night Level	Midnight to Midnight	LDN
	Daytime portion	LDay (T_{day} to T_{night})
	Nighttime portion	LNight (T_{night} to T_{day})

Overall Overload Metrics

Occurrences	Count from zero to 99999
Percent of Runtime	nnn.n%
Duration	h:mm:ss

Overall Exceedances

	UI Label	Count	Duration
SPL1	L _w > L1	Count from zero to 99999	h:mm:ss
SPL2	L _w > L2	Count from zero to 99999	h:mm:ss
Peak 1	L _w > P1	Count from zero to 99999	h:mm:ss
Peak 2	L _w > P2	Count from zero to 99999	h:mm:ss
Peak 3	L _w > P3	Count from zero to 99999	h:mm:ss

C minus A

Mathematical subtraction of C- and A-weighted equivalent levels

Linear	Units
$L_{Ceq} - L_{Aeq}$	dB

Measurement Mode Controls

These settings can be found on the meter at **Tools**→**Settings**→Mode Control.

Manual	Manually control measurements utilizing the meter display interface (Run, Pause, Resume, Stop, Store)
Timed Stop	Measurement starts manually and runs for set time (Duration) valid entries include the range of 00:00:01 (1 s) to 23:59:59
Daily Timer	Measurement runs for up to three time blocks per day, qualified by Start Date and Start Time, and End Date and End Time
Continuous	Start measurement run manually or when meter is powered on

Measurement History

These settings can be found on the meter at **Tools**→**Settings**→Measurement.

Period	Schedule for these periods: Minutes: 1, 2, 5, 10, 15, or 30; Hours: 1, 2, 4, 6
Measurement Start Date and Time Stamp	yyyy-mm-dd hh:mm:ss
Measurement History Metrics	<p>Acoustic metrics: L_{Aeq}, L_{Ceq}, L_{Ze}, L_{Aleq}, L_{Apeak}, L_{Cpeak}, L_{Zpeak} L_{ASmax}, L_{AFmax}, L_{AI}max, L_{CSmax}, L_{CFmax}, L_{CI}max, L_{ZSmax}, L_{ZFmax}, L_{ZI}max, L_{ASmin}, L_{AFmin}, L_{AI}min, L_{CSmin}, L_{CFmin}, L_{CI}min, L_{ZSmin}, L_{ZFmin}, L_{ZI}min, Overloads, LN Percentiles</p> <p>Non-acoustic metrics: Run time in seconds, pause time in seconds</p>

Time History Measurement System

<p>Period</p>	<p>Schedule for these periods: Milliseconds: 100; Seconds: 1, 2, 5, 10, 15, or 30; Minutes: 1, 2, 5, 10, 15, or 30; Hours: 1</p>
<p>Occurrence Date and Time Stamp</p>	<p>yyyy-mm-dd hh:mm:ss</p>
<p>Time History Metrics</p>	<p>Acoustic metrics: LAeq, LCEq, LZeq, LApeak, LCpeak, LZpeak LASmax, LAFmax, LAImax, LCSmax, LCFmax, LCImax, LZSmax, LZFmax, LZImax, LASmin, LAFmin, LAImin, LCSmin, LCFmin, LCImin, LZSmin, LZFmin, LZImin, Overload, OBA Leq, Lmax, Lmin*, TWA3, TWA5†</p> <p>Non-acoustic metrics: Time in milliseconds (Tms, period < 1s), Battery Percentage, External Voltage, Power Source</p> <p>*OBA processing must be installed (Firmware Option 721/821-OB3), and the OBA Time History setting must be enabled on the meter. †Used for post-processing Dosimetry recalculations. Requires Dosimetry option for SoundExpert models</p>

Industrial Hygiene Specifications

* For units with X21-DOS option installed

Compliance; Standards Met	IEC 61252 Ed. 1.2 b:2017 ANSI S1.25-1991 (R2017)			
Virtual Dosimeter Metrics Activate up to four virtual dosimeters to measure for various criteria or requirements.	Configurations (Predefined and Custom)	OSHA-HA, OSHA-PEL, ACGIH, NIOSH, ISO-9612, Canada, or "CUSTOM"		
	Frequency Weightings (Including Peak)	A, C, or Z		
	Exchange Rates	Selectable (3, 4, 5, or 6 dB)		
	Criterion Level	Selectable from 55 to 100 dB with 0.1 dB resolution		
	Threshold	Selectable from 55 to 100 dB with 0.1 dB resolution, or disabled		
	Shift Time	Selectable from 1 to 24 hours with 0.1 resolution		
	Pulse Range	98 dB		
	Measurement Metrics (DOSE)		Metric	Label
		Noise Dose	DOSE	%
		Projected Noise Dose	P.Dose	%
		Average Level with Threshold	L_{avg}	dB
		Time Weighted Average	TWA(8)	dB
		Projected Time Weighted Average	P.TWA(8)	dB
		Daily Personal Noise Exposure	LEP,d/LEX,8h	dB
		Projected Daily Personal Noise Exposure	PLEP,d	dB
Maximum Exposure (limit 140 dB for 200 hours)	7.90E+06 Pa²h			
Minimum Exposure (limit 50 dB for 1 second)	7.90E-03 Pa²s			
Deviation due to unipolar pulses	Typical deviation between positive and negative pulses is 2%.			

A.3 Model PRM721 and PRM821 Specifications

The Larson Davis PRM721 and PRM821 are electret microphone preamplifiers for use with Larson Davis 721 or 821 sound level meters. They require little supply current and are capable of driving 200 feet of cable. The preamplifiers operate over wide ranges of temperature and humidity, have very little attenuation, and are for use with multiple microphones.

Frequency Response	5 Hz to 126 Hz, (+0.45/-0.53) dB 16 Hz to 100 kHz +0.1, -0.1 dB
Low Frequency Response (High-Pass Filter)	Lower -3 dB limit < 1.5 Hz
Attenuation	0.1 dB (typical)
Input Impedance	10 G Ohm // 0.16 pF (typical)
Output Impedance	50 Ohm (typical)
Maximum Output Voltage	28 Vpp, 143 dB peak for microphones with 50 mV/Pa sensitivity
Maximum Output Current	12 mA peak
Distortion Harmonics	< -70 dBc with 8-Volt rms output at 1 kHz
Output Slew Rate	2 V/μS (typical)
Electronic Noise (with 12 pF equivalent microphone)	2.3 μV typical, A-weighted (2.4 μV max) 5.0μV typical Flat, 20 Hz to 20 kHz, (6.0 μV max)
Power Supply Voltage	15 to 36 Volts
DC Output Level	0.5 x power supply voltage
Power Supply Current	1.9 mA (typical)
Temperature Sensitivity	< ±0.05 dB from -40° to +80° C (-40° to +176 °F)
Humidity Sensitivity	< ±0.05 dB from 0 to 90% RH, non-condensing
Dimensions	12.7 mm diameter x 73 mm length (0.5 in diameter x 2.88 in length)
Microphone Thread	11.7 mm - 60 UNS (0.4606 - 60 UNS)
Compatibility	LD 377B02 or any 1/2-inch electret microphone 1/4-in or 1-in microphones With ADP043 or ADP008A adapters

Output Connector: Switchcraft TA5M 5-Pin male

Pin	Signal
1	Signal Ground
2	Signal Output
3	Power Supply + 35 Volts
4	Preamp sensor
5	No Connection
Shell	Connect to preamp housing

A.4 Octave Band Analysis Specifications

In this section:

- [Compliance/Standards Met](#)
- [OBA Filter Description](#)
- [OBA Measurement Range Specifications](#)
- [OBA Filter Shape Description](#)
- [OBA Filter Linearity Range](#)
- [Instrument Noise Levels With OBA](#)

Compliance/Standards Met

Octave Filter Standards	IEC 61260-1:2014/Part 1, 1/1 and 1/3-Octave Bands, Class 1, Group X, all filters
	ANSI/ASA S1.11-2014/Part 1, 1/1 and 1/3-octave Bands, Class 1, Group X, all filters

OBA Filter Description

Bandwidth Filter Selections	None, 1/1 octave, 1/3 octave
Filter Type	Digital Filters with Base 10 center frequencies
Sample Rate	48,000 S/s
Reference Attenuation	0 dB
Reference Signal Level	0.5 Vrms
1/1 Octave Center Frequencies	8 Hz to 16 kHz (Base 10)
1/3 Octave Center Frequencies	6.3 Hz to 20 kHz (Base 10)

OBA Measurement Range Specifications

OBA Measurement Range	128 dB full scale at reference range and frequency
Measurement System Details	Specified Frequency Weighting is A, C, or Z independent of broadband weightings
Specified Time Weightings/ Detectors	Follows meter setting for Time Weighting/Detector (S, F, or I) indicated by τ
Metrics	A, C, Z

OBA Filter Shape Description

Filter shapes for this instrument meet the requirements of the standards listed on [A.1.1 Compliance or Standards Met](#)

OBA Filter Linearity Range

Octave band linearity was measured electrically by using the input adapter ADP090.

The following tables provide details for PRM821. Results for the preamplifier PRM721 are the same as the PRM821.

- **Table A.4 "OBA 1/1 Octave Linearity Range"**
- **Table A.5 "OBA 1/3 Octave Linearity Range"**

TABLE A.4 OBA 1/1 Octave Linearity Range

Nominal Frequency (Hz)	Range (dB)
8.0	31 to 140
16.0	27 to 140
31.5	24 to 140
63.0	23 to 140
125	18 to 140
250	15 to 140
500	13 to 140
1000	14 to 140
2000	15 to 140
4000	16 to 140
8000	18 to 140
16000	21 to 140

Table A.5 OBA 1/3 Octave Linearity Range

Nominal Frequency (Hz)	Range (dB)
6.3	34 to 140
8.0	31 to 140
10.0	30 to 140
12.5	29 to 140
16.0	28 to 140
20.0	27 to 140

Table A.5 OBA 1/3 Octave Linearity Range (Continued)

25.0	26 to 140
31.5	25 to 140
40.0	23 to 140
50.0	20 to 140
63.0	16 to 140
80.0	15 to 140
100	14 to 140
125	14 to 140
160	12 to 140
200	11 to 140
250	10 to 140
315	9 to 140
400	8 to 140
500	8 to 140
630	8 to 140
800	8 to 140
1000	8 to 140
1250	8 to 140
1600	8 to 140
2000	8 to 140
2500	9 to 140
3150	10 to 140
4000	11 to 140
5000	11 to 140
6300	12 to 140
8000	13 to 140
10000	14 to 140
12500	15 to 140
16000	17 to 140
20000	18 to 140

Instrument Noise Levels With OBA

The following charts show the 721 and 821 typical instrument noise levels for the OBA filter with the PRM721 or PRM821.

FIGURE A-12 Self-Generated Noise Levels for 1/1 Octave Filter With PRM821 or PRM721

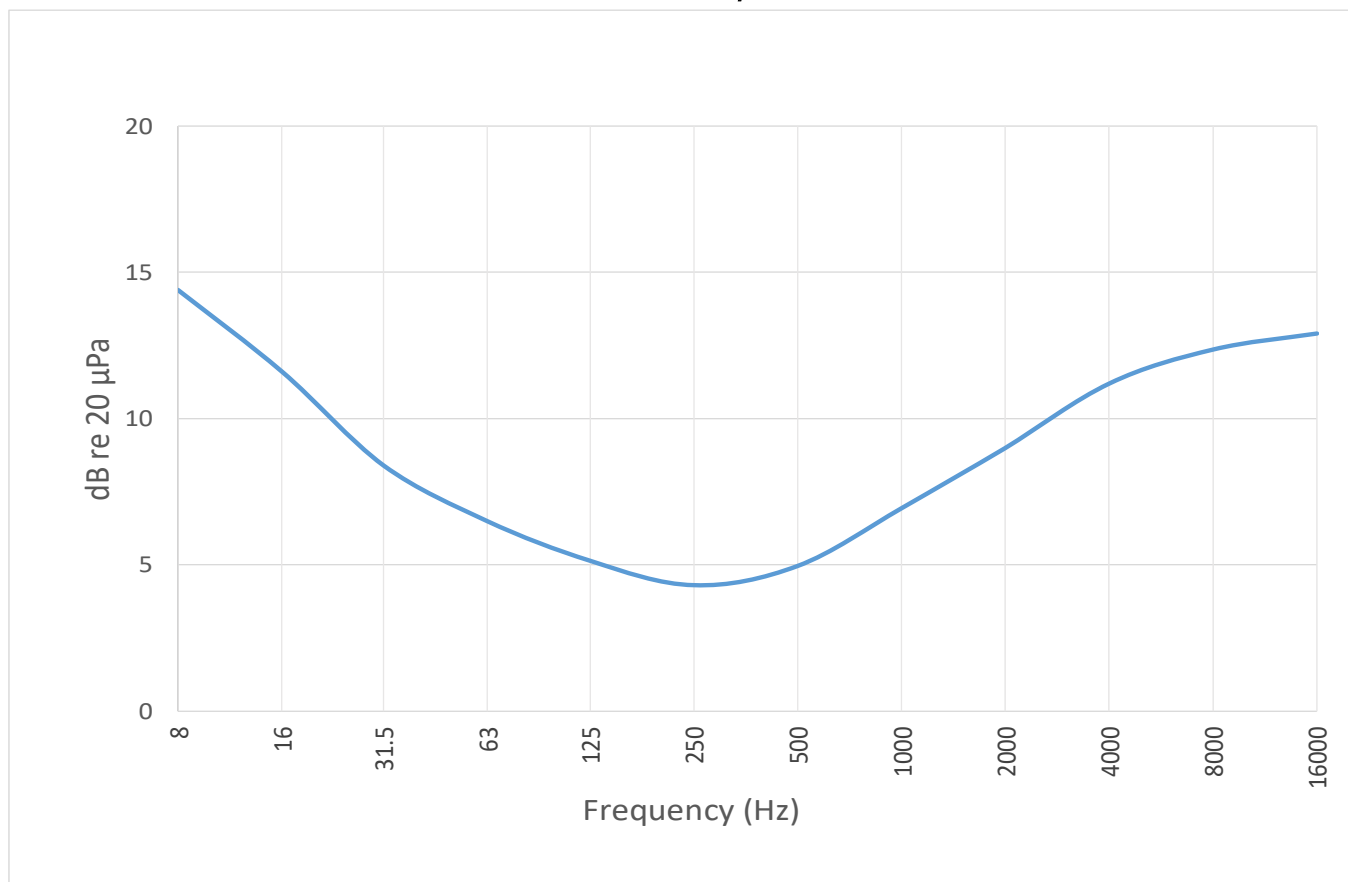
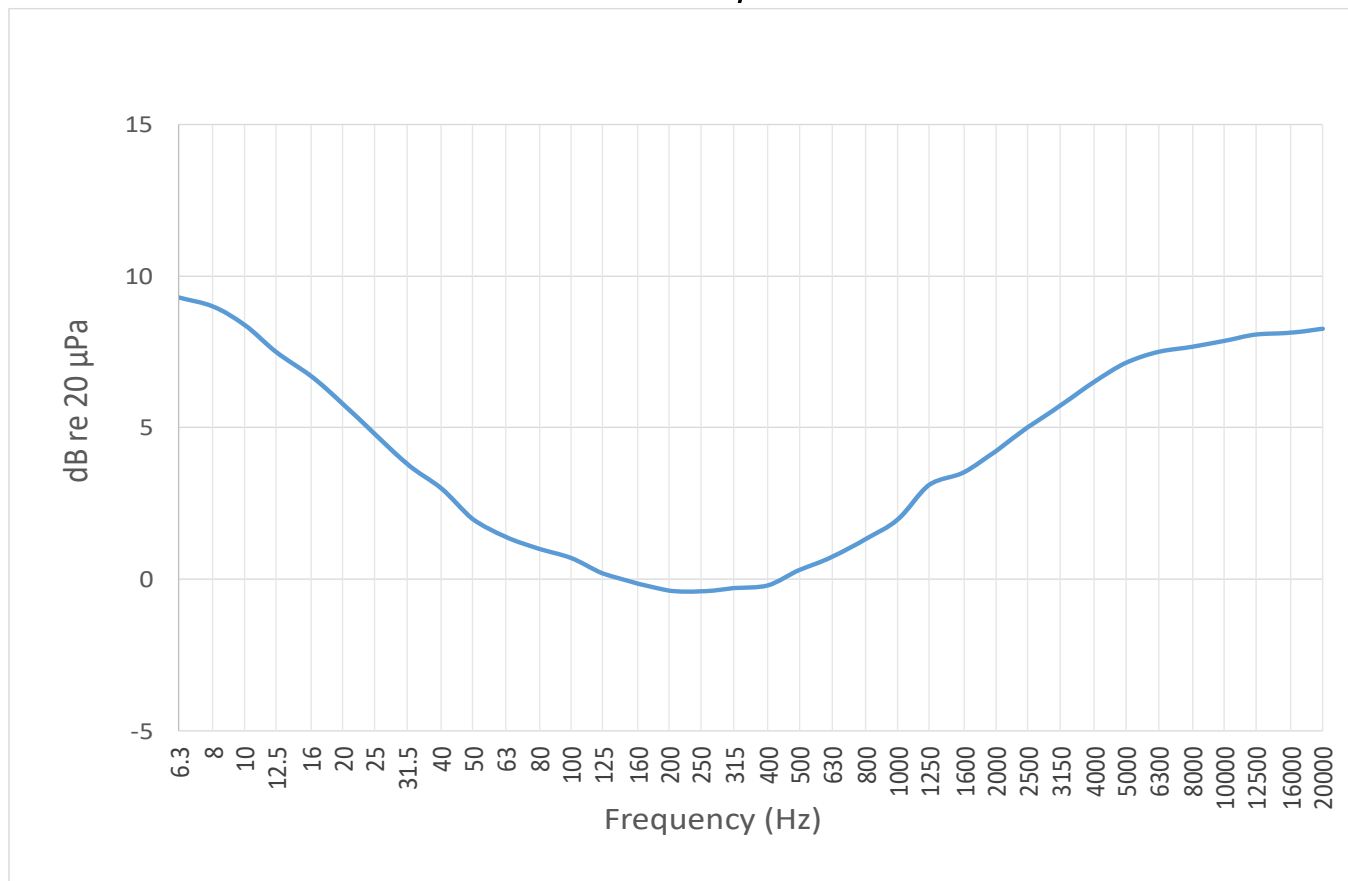

FIGURE A-13 Self-Generated Noise Levels for 1/3 Octave Filter With PRM821 or PRM721



A.5 Directional Response

The following data was taken using the Model 821 sound level meter with a PRM821 preamplifier at degrees increasing by 10, starting with 0° and rotating to 350°.

In this section:

- [A.5.1 XY Plane Frequency Response](#)
- [A.5.2 XZ Plane Frequency Response](#)
- [A.5.3 Directional Response Tables Without Windscreen](#)

A.5.1 XY Plane Frequency Response

FIGURE A-14 XY Plane Reference Direction; Plane Parallel To Display Screen

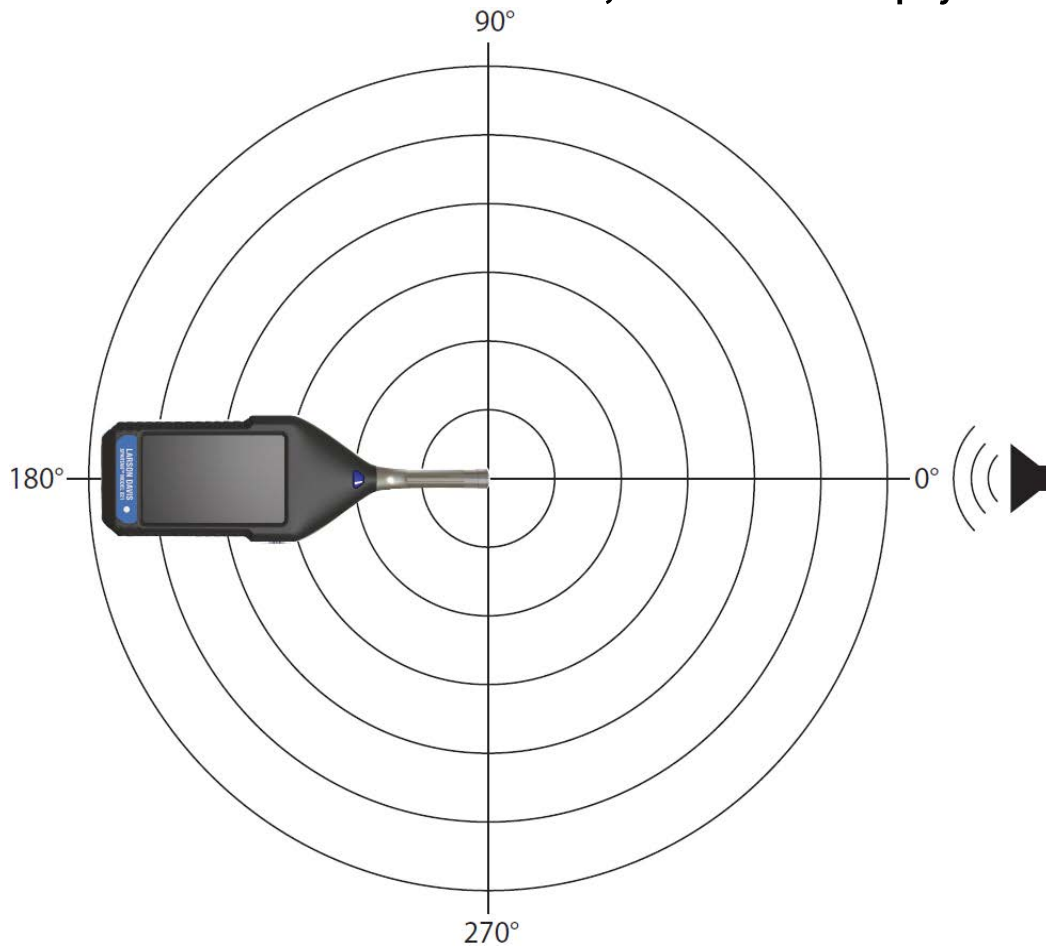

FIGURE A-15 Model 821 with 377B02 Microphone, No Windscreen/ XY Plane

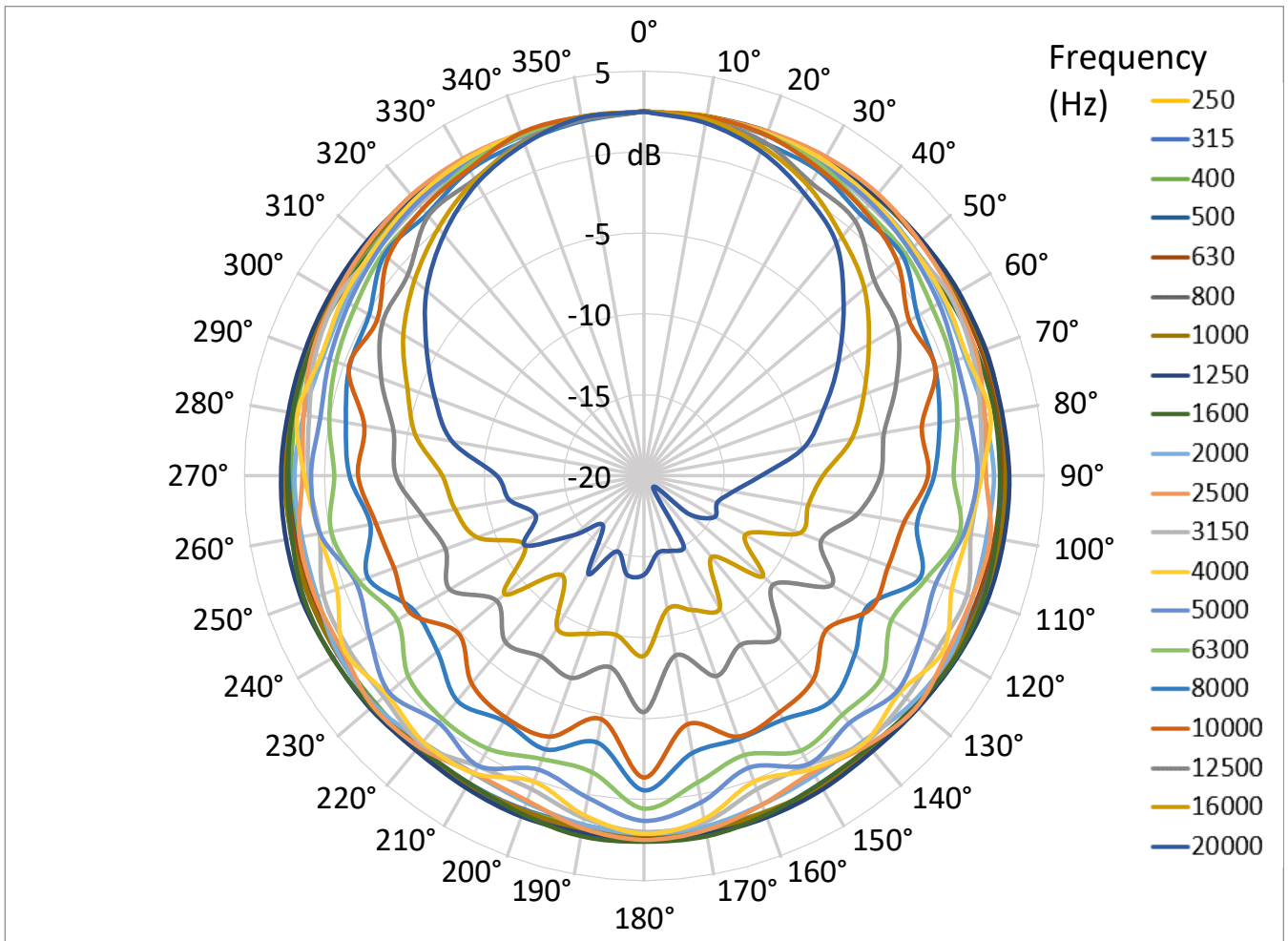

FIGURE A-16 Model 821 with 377B02 Microphone With Windscreen/ XY Plane

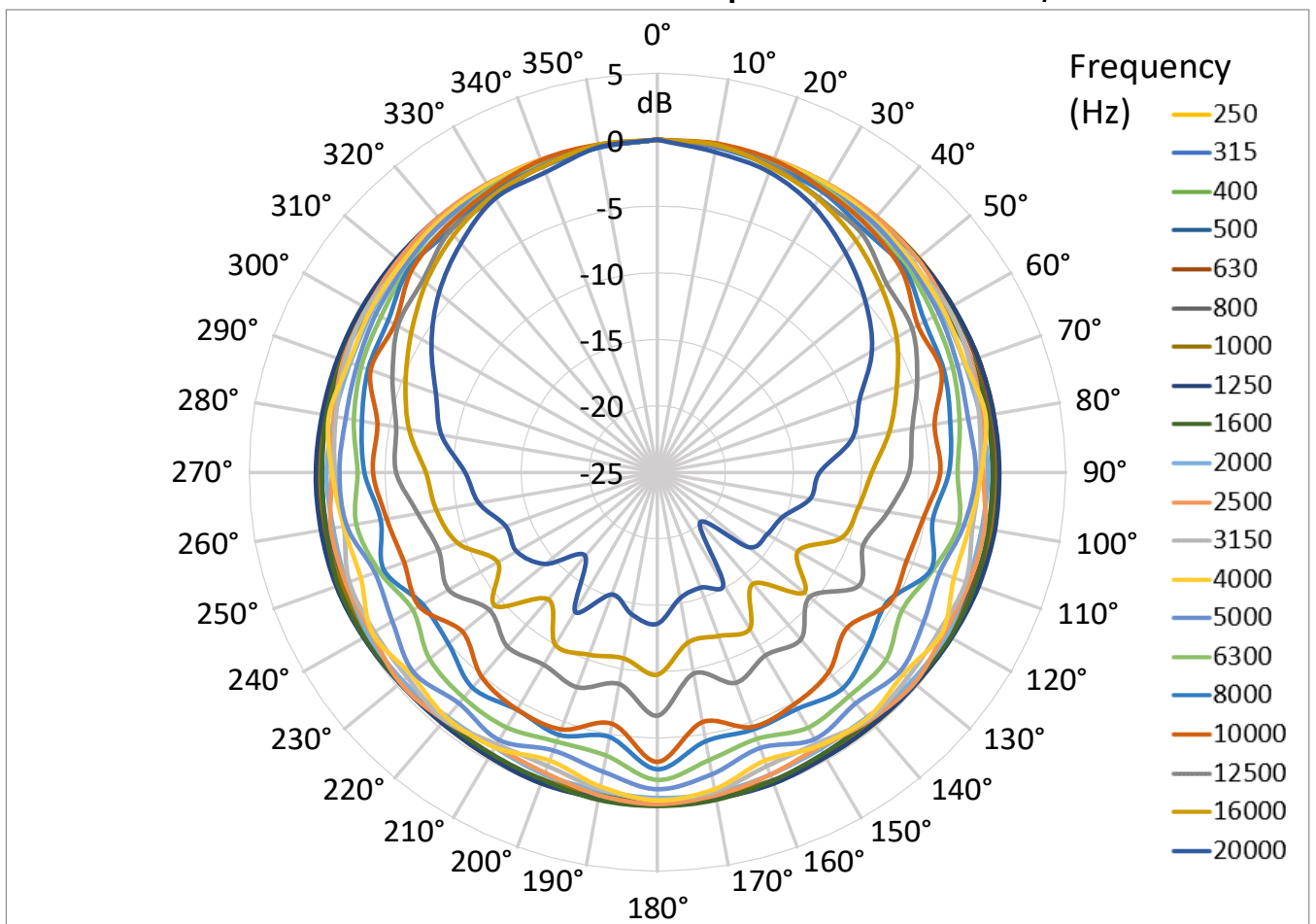

FIGURE A-17 XY Plane Directional Response Chart 1: Relative to 1000 Hz at 0°

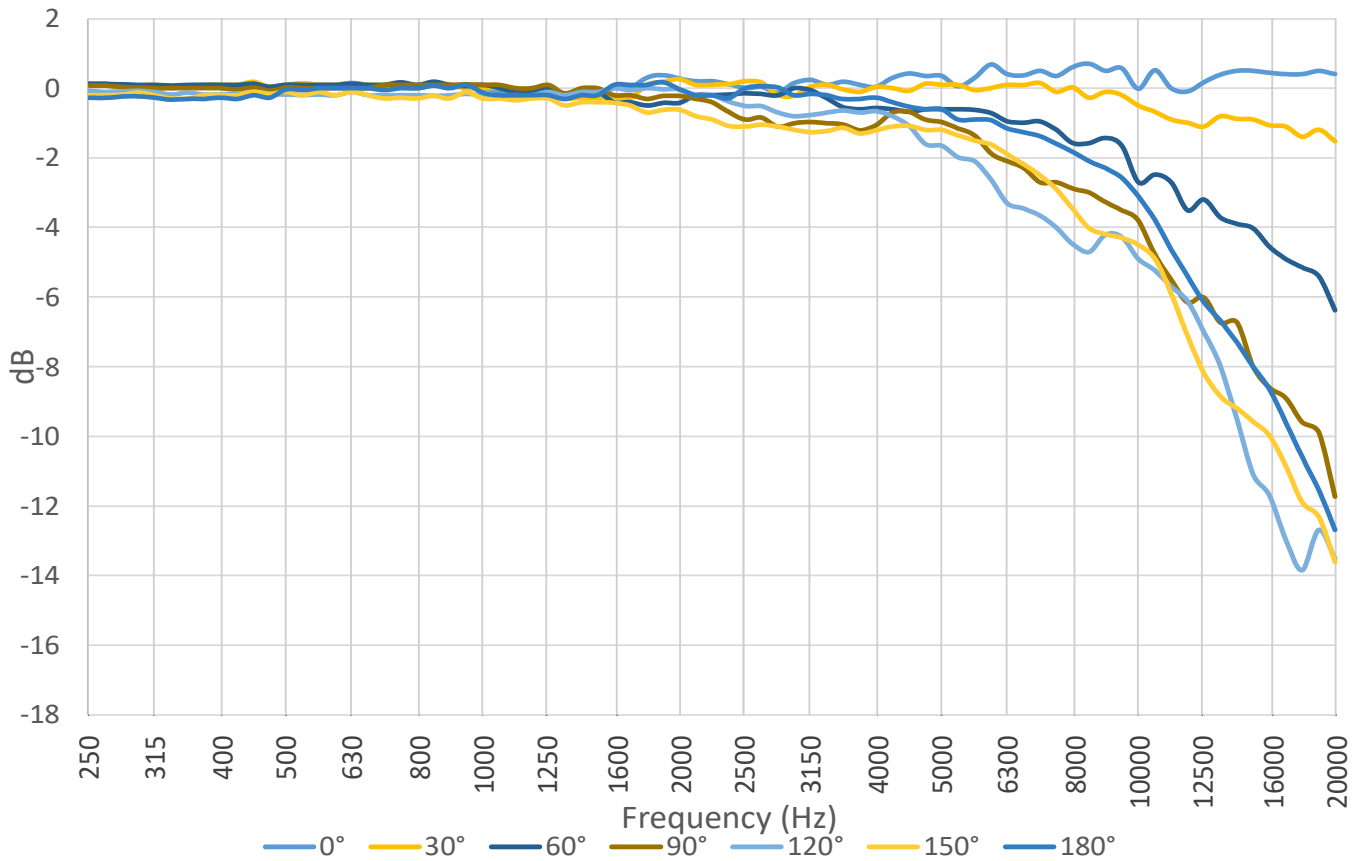

FIGURE A-18 XY Plane Directional Response Chart 2: Relative to 1000 Hz at 0°

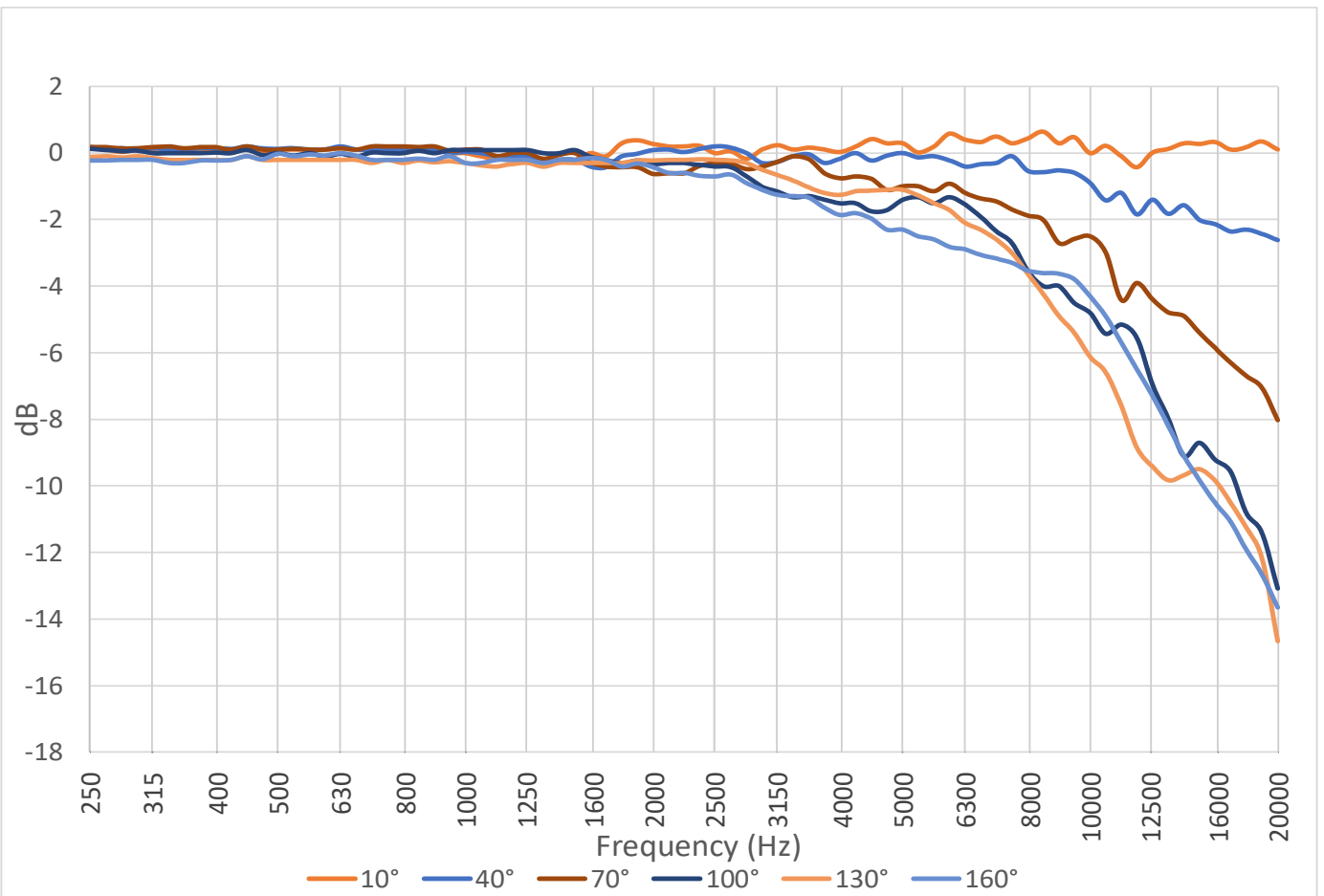
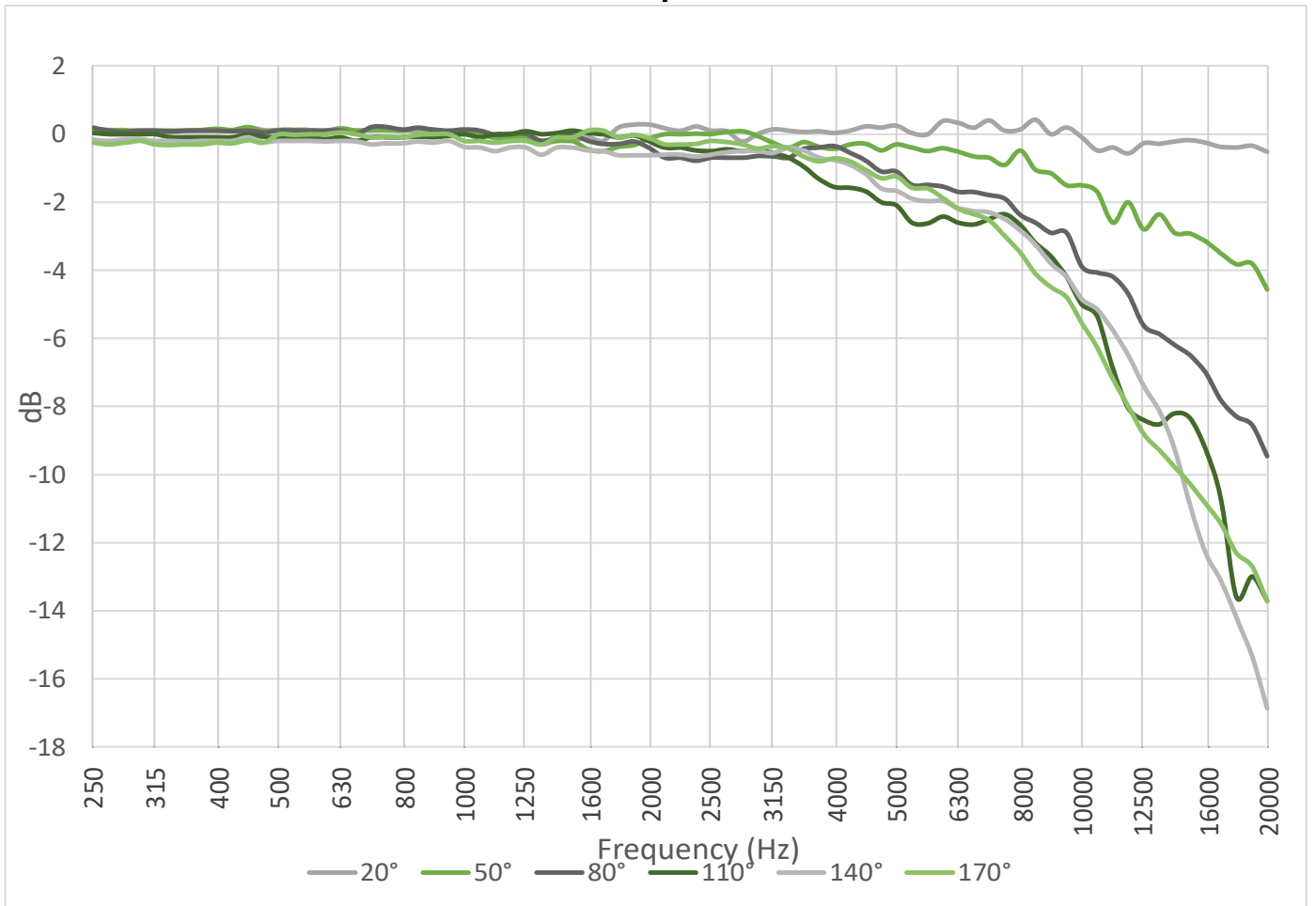

FIGURE A-19 XY Plane Directional Response Chart 3: Relative to 1000 Hz at 0°



A.5.2 XZ Plane Frequency Response

FIGURE A-20 XZ Plane Reference Direction; Plane Perpendicular To Display Screen

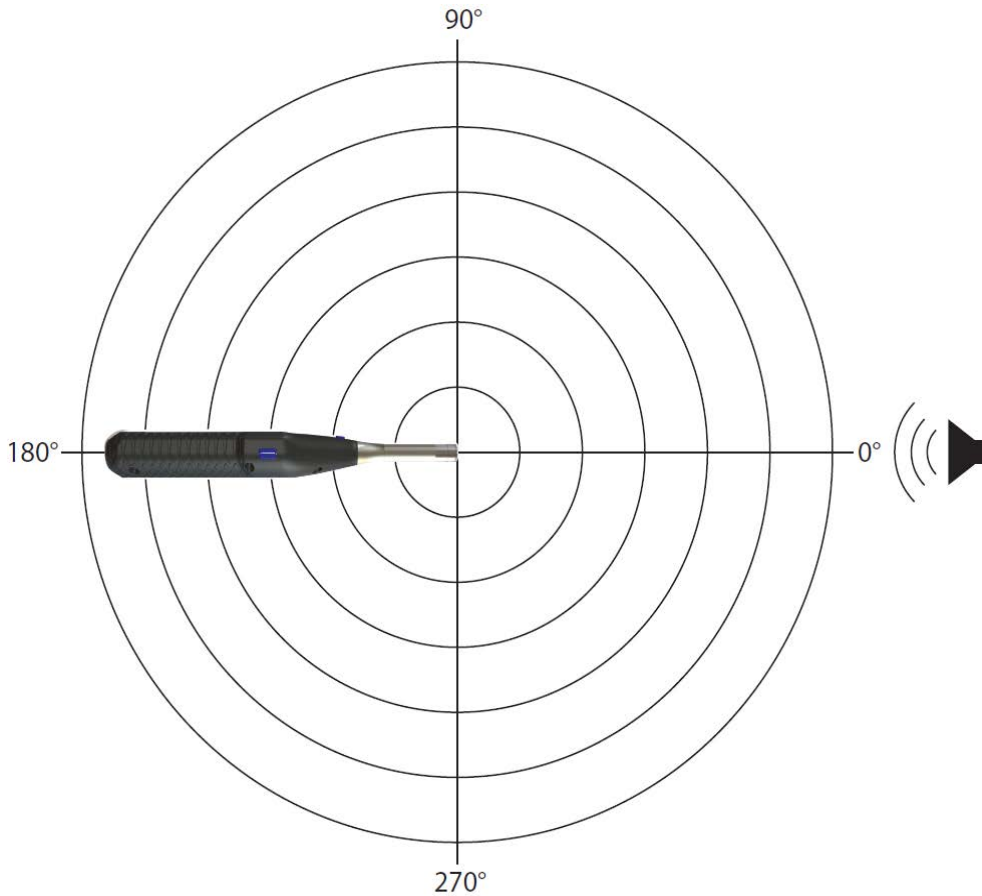

FIGURE A-21 XZ Plane Response: Model 821 with 377B02 Microphone, No Windscreen

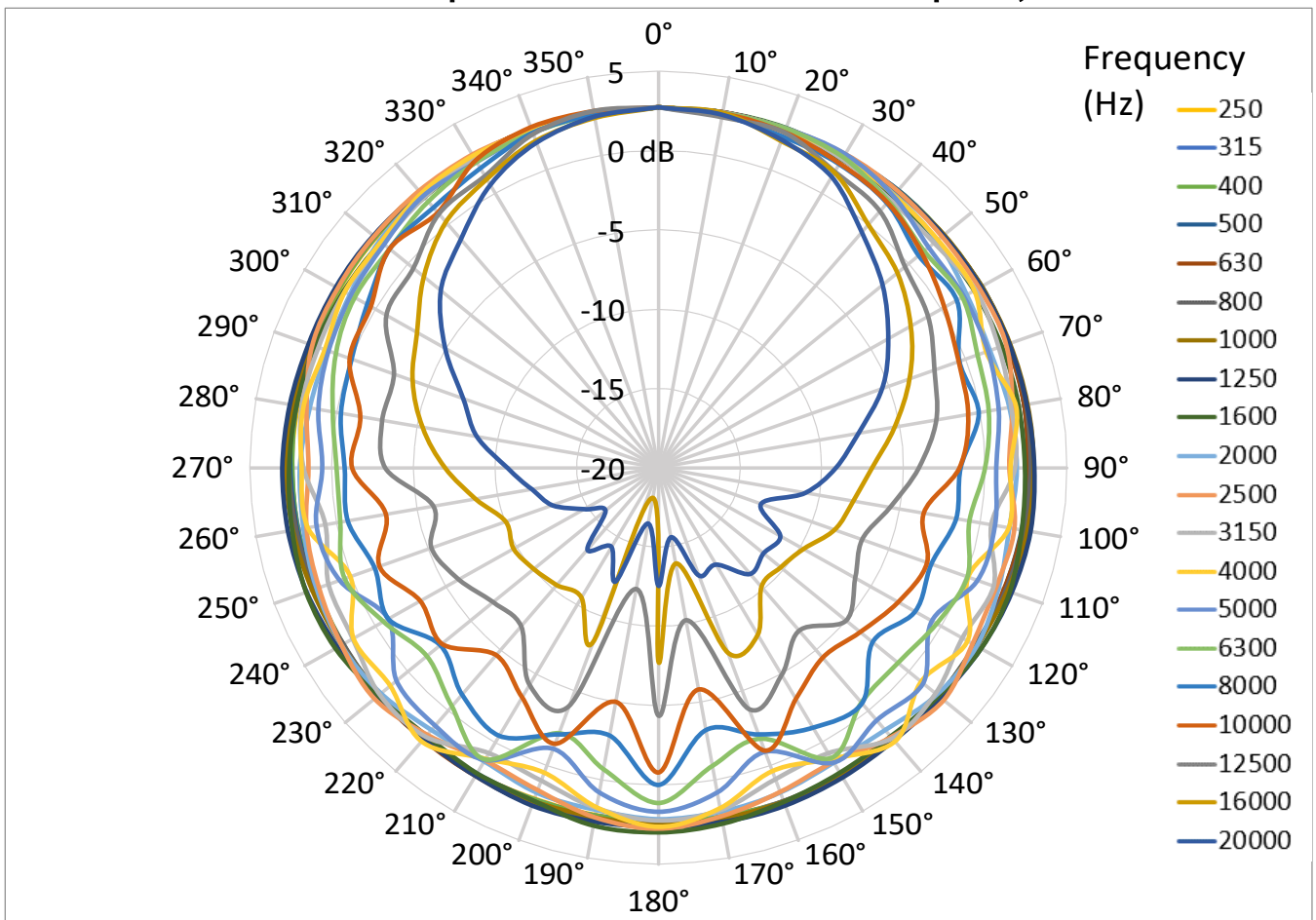

FIGURE A-22 XZ Plane Response: Model 821 with 377B02 Microphone With Windscreen

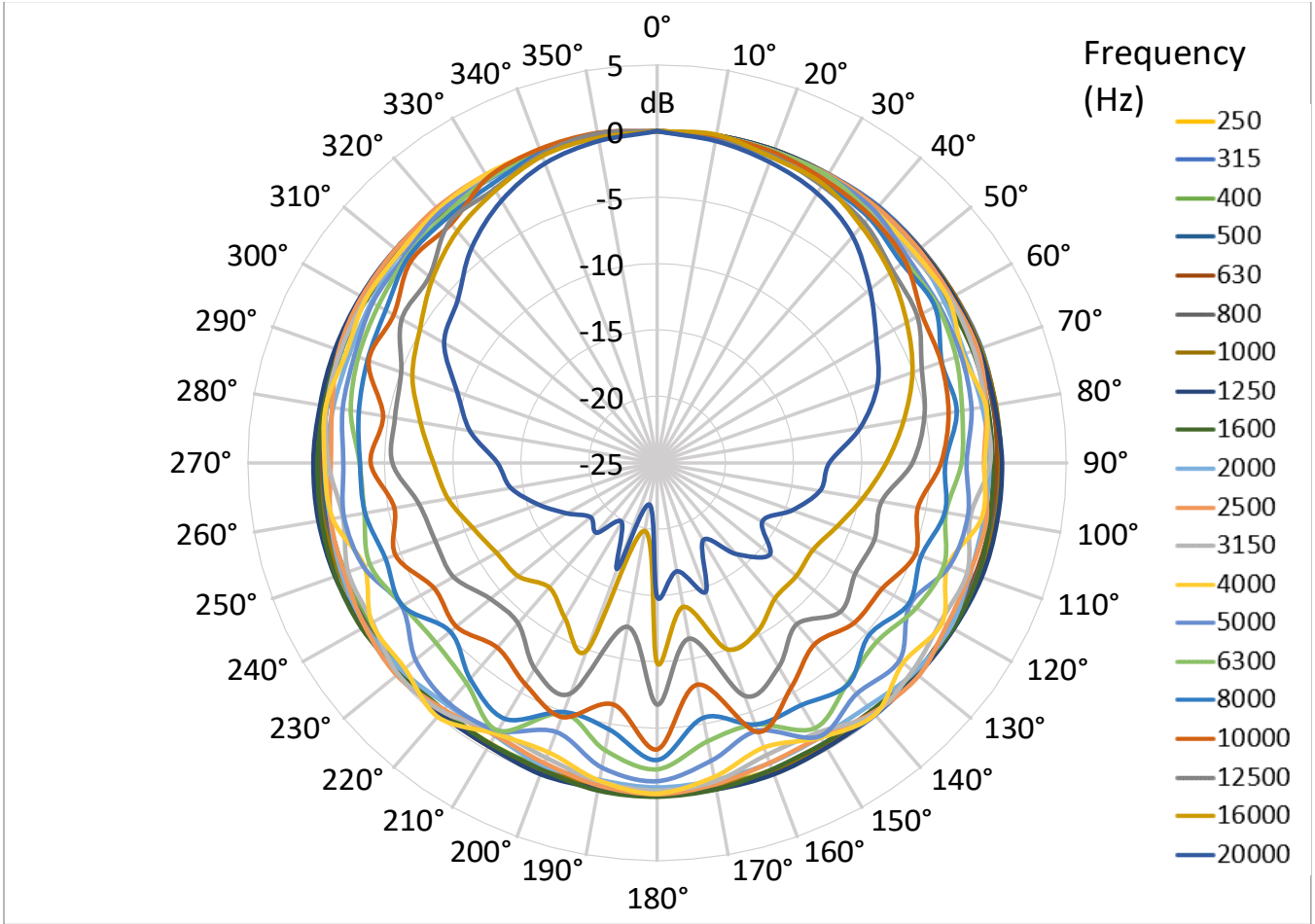

FIGURE A-23 XZ Plane Directional Response Chart 1: Relative to 1000 Hz at 0°

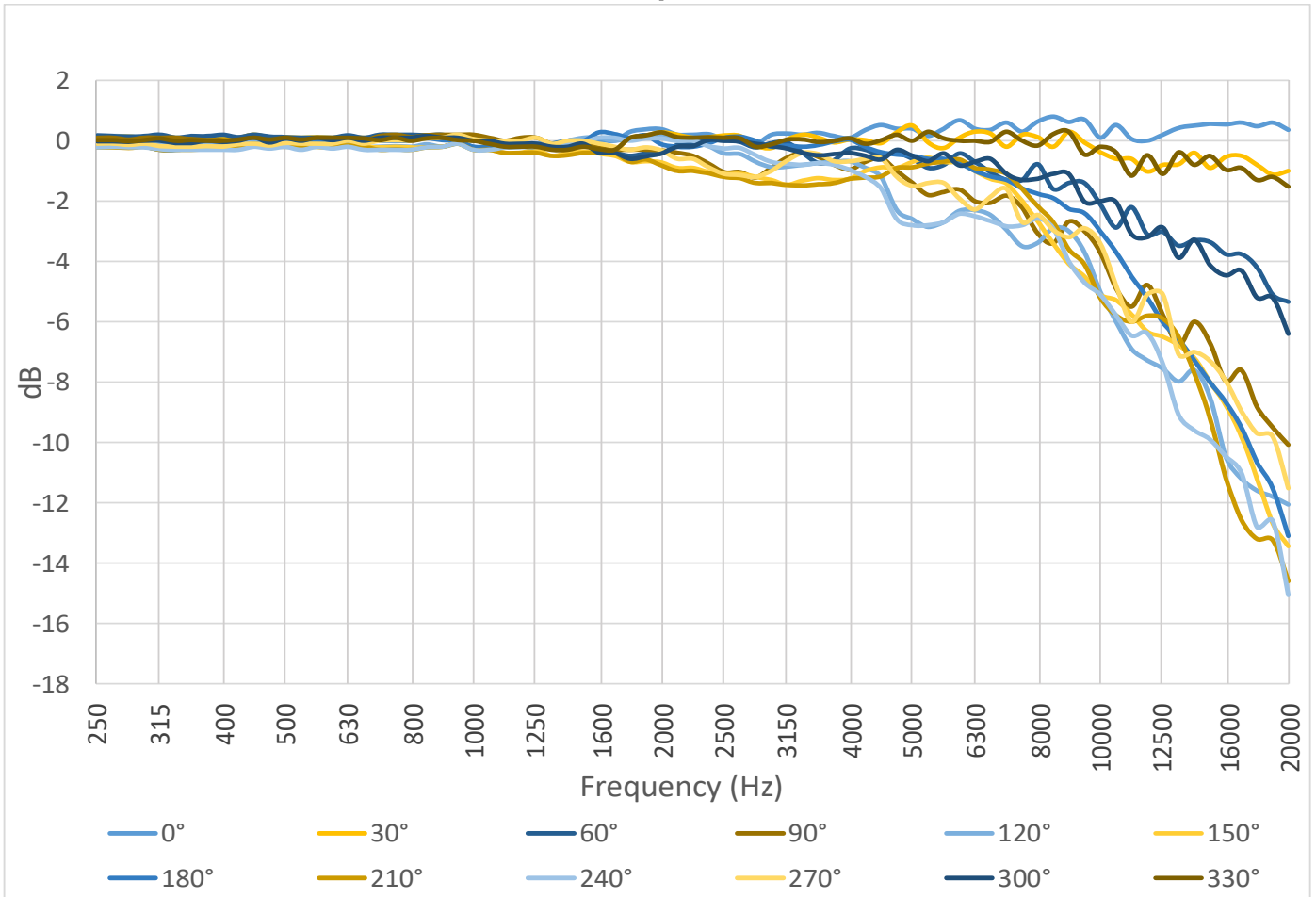

FIGURE A-24 XZ Plane Directional Response Chart 2: Relative to 1000 Hz at 0°

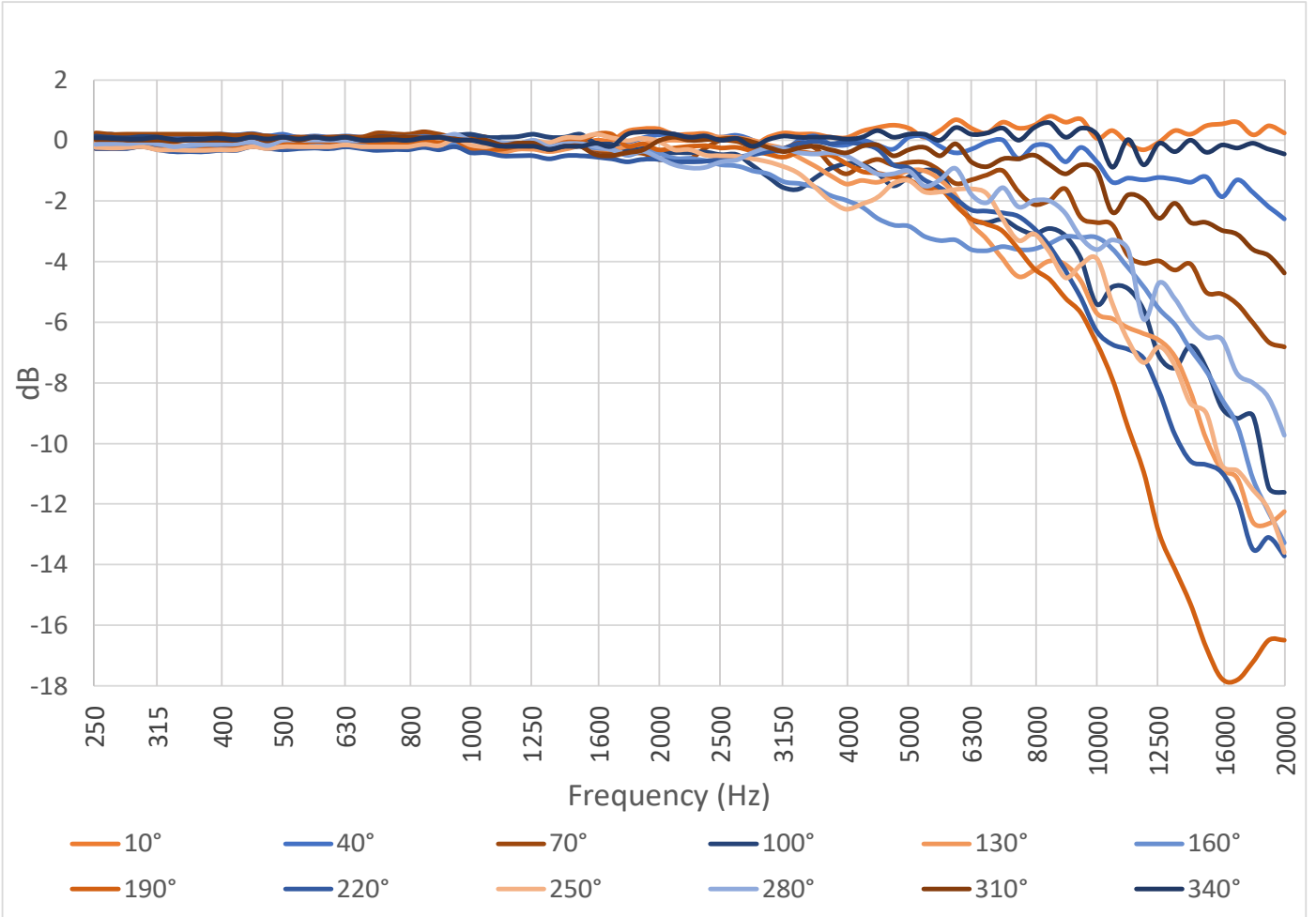
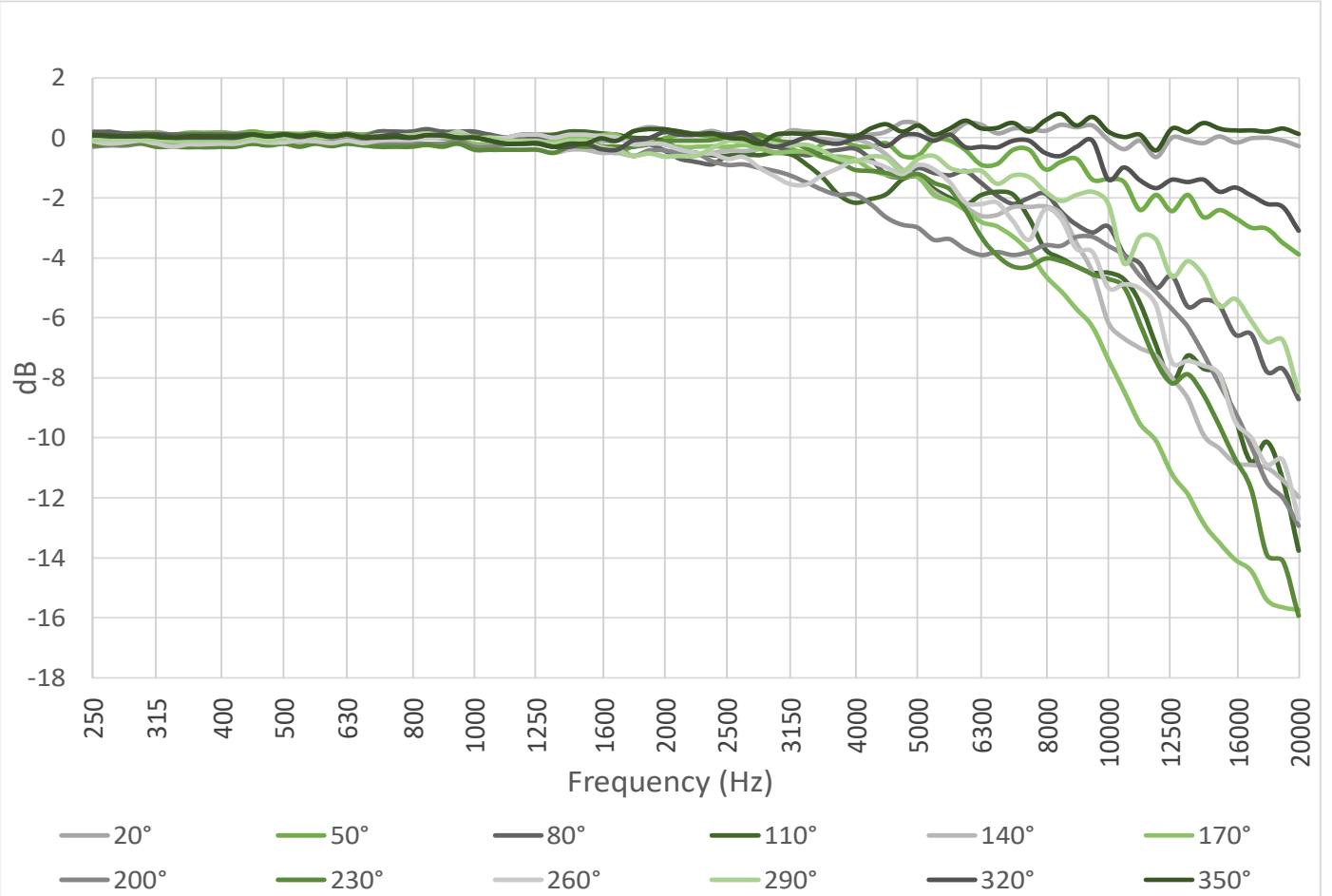

FIGURE A-25 XZ Plane Directional Response Chart 3: Relative to 1000 Hz at 0°



A.5.3 Directional Response Tables Without Windscreen

For windscreen effects on directional response, see **Table B.3 Directional Response (from 0° to 90°) of 3 ½-inch Windscreen** and **Table B.4 Directional Response (from 100° to 180°) of 3 ½-inch Windscreen**

TABLE A.6 XY Directional Response without Windscreen 250 Hz - 2.8 kHz

Angle	Nominal Frequency												
	250 Hz	315 Hz	400 Hz	500 Hz	630 Hz	800 Hz	1 kHz	1.25 kHz	1.6 kHz	2 kHz	2.24 kHz	2.5 kHz	2.8 kHz
0°	0.00	0.00	0.00	0.00	0.00	0.00	0.00	0.00	0.00	0.00	0.00	0.00	0.00
10°	0.08	0.02	0.00	0.00	0.00	0.03	0.00	0.00	0.00	0.00	0.00	0.00	-0.05
20°	0.00	0.02	0.00	0.00	0.02	0.10	0.00	0.05	-0.10	0.00	-0.10	0.10	-0.10
30°	0.00	0.02	0.00	0.00	-0.03	0.05	0.00	0.07	-0.25	-0.02	-0.10	0.20	-0.08
40°	0.10	0.08	0.05	0.03	0.05	0.10	0.03	0.07	-0.40	-0.20	-0.17	0.20	0.12
50°	0.08	0.02	0.05	0.03	0.00	0.10	0.10	0.13	-0.45	-0.40	-0.20	0.00	0.20
60°	0.05	0.02	0.00	0.00	-0.03	0.10	0.10	0.17	-0.40	-0.70	-0.40	-0.15	-0.08
70°	0.10	0.10	0.08	0.00	0.00	0.20	0.10	0.17	-0.27	-0.90	-0.80	-0.30	-0.35
80°	0.10	0.02	0.00	0.00	-0.05	0.13	0.13	0.17	-0.20	-0.70	-0.90	-0.70	-0.58
90°	0.00	-0.08	-0.10	-0.07	-0.15	0.10	0.10	0.27	-0.20	-0.50	-0.60	-0.90	-0.98
100°	0.05	-0.08	-0.07	-0.10	-0.18	0.00	0.10	0.27	-0.10	-0.60	-0.50	-0.40	-0.58
110°	-0.05	-0.08	-0.20	-0.20	-0.25	-0.10	0.00	0.25	0.03	-0.50	-0.60	-0.50	-0.38
120°	-0.15	-0.18	-0.27	-0.27	-0.25	-0.20	-0.20	0.07	0.00	-0.30	-0.40	-0.50	-0.58
130°	-0.20	-0.22	-0.30	-0.30	-0.35	-0.30	-0.30	-0.13	-0.30	-0.50	-0.40	-0.20	-0.18
140°	-0.25	-0.28	-0.30	-0.30	-0.35	-0.27	-0.37	-0.23	-0.47	-0.90	-0.80	-0.60	-0.38
150°	-0.27	-0.28	-0.30	-0.20	-0.25	-0.30	-0.30	-0.13	-0.42	-0.90	-1.10	-1.10	-0.98
160°	-0.30	-0.28	-0.32	-0.12	-0.15	-0.20	-0.30	-0.03	-0.15	-0.70	-0.80	-0.70	-0.78
170°	-0.32	-0.38	-0.35	-0.10	-0.10	-0.10	-0.20	-0.03	0.10	-0.40	-0.50	-0.20	-0.18
180°	-0.35	-0.35	-0.37	-0.12	-0.15	0.00	-0.12	-0.03	0.10	-0.30	-0.40	0.00	0.15
190°	-0.42	-0.48	-0.42	-0.17	-0.15	-0.10	-0.27	-0.07	0.10	-0.50	-0.60	-0.30	-0.18
200°	-0.40	-0.45	-0.40	-0.20	-0.25	-0.30	-0.37	-0.07	-0.20	-0.80	-0.80	-0.90	-0.95
210°	-0.40	-0.48	-0.42	-0.30	-0.33	-0.30	-0.40	-0.17	-0.45	-1.00	-1.10	-1.00	-0.98
220°	-0.40	-0.48	-0.47	-0.40	-0.35	-0.37	-0.50	-0.27	-0.45	-0.80	-0.80	-0.50	-0.28
230°	-0.37	-0.48	-0.47	-0.40	-0.35	-0.40	-0.40	-0.13	-0.20	-0.40	-0.40	-0.27	-0.18
240°	-0.37	-0.40	-0.40	-0.35	-0.35	-0.30	-0.30	-0.03	0.00	-0.35	-0.45	-0.60	-0.58
250°	-0.37	-0.48	-0.47	-0.32	-0.35	-0.20	-0.20	0.17	0.08	-0.60	-0.70	-0.50	-0.28
260°	-0.30	-0.35	-0.40	-0.27	-0.25	-0.10	-0.10	0.20	-0.10	-0.60	-0.60	-0.50	-0.60
270°	-0.32	-0.28	-0.32	-0.20	-0.15	-0.05	0.00	0.17	-0.15	-0.50	-0.70	-0.90	-0.90
280°	-0.25	-0.28	-0.30	-0.10	-0.15	0.00	0.00	0.07	-0.15	-0.70	-0.92	-0.70	-0.48

TABLE A.6 XY Directional Response without Windscreen 250 Hz - 2.8 kHz (Continued)

Angle	Nominal Frequency												
	250 Hz	315 Hz	400 Hz	500 Hz	630 Hz	800 Hz	1 kHz	1.25 kHz	1.6 kHz	2 kHz	2.24 kHz	2.5 kHz	2.8 kHz
290°	-0.17	-0.18	-0.20	-0.10	-0.05	0.00	0.00	0.07	-0.20	-0.90	-0.80	-0.32	-0.28
300°	-0.12	-0.18	-0.17	-0.07	-0.05	0.00	-0.10	0.07	-0.35	-0.72	-0.40	-0.20	-0.08
310°	-0.10	-0.10	-0.17	0.00	-0.05	0.00	-0.10	0.07	-0.40	-0.40	-0.30	-0.02	0.22
320°	-0.10	-0.10	-0.10	0.00	-0.05	0.00	-0.10	0.03	-0.40	-0.20	-0.20	0.10	0.12
330°	-0.07	-0.08	-0.10	0.00	-0.05	0.00	-0.10	-0.03	-0.25	-0.10	-0.10	0.10	-0.08
340°	-0.05	-0.08	-0.10	0.00	-0.05	0.00	-0.10	-0.03	-0.10	-0.07	-0.10	0.00	-0.10
350°	-0.02	-0.08	-0.10	0.00	-0.05	0.00	-0.10	-0.03	-0.02	-0.10	-0.10	0.00	-0.08

TABLE A.7 XY Directional Response without Windscreen 3.15 kHz - 10 kHz

Angle	Nominal Frequency												
	3.15 kHz	3.55 kHz	4 kHz	4.5 kHz	5 kHz	5.6 kHz	6.3 kHz	7.1 kHz	8 kHz	8.5 kHz	9 kHz	9.5 kHz	10 kHz
0°	0.00	0.00	0.00	0.00	0.00	0.00	0.00	0.00	0.00	0.00	0.00	0.00	0.00
10°	0.00	-0.03	0.00	0.00	-0.05	-0.10	0.00	0.00	-0.17	-0.05	-0.20	-0.10	0.02
20°	-0.10	-0.13	0.00	-0.20	-0.10	-0.30	-0.07	-0.10	-0.47	-0.27	-0.50	-0.38	-0.08
30°	-0.20	-0.23	0.00	-0.50	-0.25	-0.35	-0.30	-0.35	-0.60	-0.97	-0.60	-0.78	-0.48
40°	-0.50	-0.23	-0.20	-0.65	-0.35	-0.40	-0.80	-0.80	-1.15	-1.27	-1.02	-1.18	-0.88
50°	-0.50	-0.43	-0.47	-0.70	-0.65	-0.80	-0.92	-1.20	-1.10	-1.75	-1.65	-2.08	-1.48
60°	-0.30	-0.73	-0.60	-1.10	-0.95	-0.92	-1.35	-1.45	-2.20	-2.27	-1.92	-2.22	-2.68
70°	-0.50	-0.37	-0.80	-1.20	-1.35	-1.45	-1.60	-1.95	-2.50	-2.70	-3.20	-3.15	-2.48
80°	-0.90	-0.63	-0.40	-1.20	-1.45	-1.80	-2.10	-2.30	-3.00	-3.30	-3.40	-3.48	-3.88
90°	-1.20	-1.23	-1.10	-1.10	-1.33	-1.65	-2.50	-3.20	-3.50	-3.70	-3.77	-4.08	-3.78
100°	-1.40	-1.47	-1.55	-2.17	-1.75	-1.80	-1.95	-2.85	-4.15	-4.70	-4.50	-5.08	-4.78
110°	-0.80	-1.15	-1.60	-2.10	-2.45	-2.92	-3.00	-3.00	-3.30	-3.90	-4.10	-4.78	-4.98
120°	-1.00	-0.83	-0.70	-1.50	-2.00	-2.40	-3.70	-4.15	-5.10	-5.40	-4.70	-4.85	-4.88
130°	-0.90	-1.23	-1.30	-1.55	-1.45	-1.80	-2.50	-3.10	-4.25	-4.92	-5.40	-5.98	-6.10
140°	-0.80	-0.67	-0.80	-1.60	-2.03	-2.27	-2.57	-2.80	-3.45	-3.95	-4.30	-4.78	-4.82
150°	-1.50	-1.33	-1.25	-1.50	-1.55	-1.80	-2.30	-3.00	-4.10	-4.72	-4.70	-4.88	-4.48
160°	-1.50	-1.53	-1.90	-2.40	-2.65	-2.90	-3.30	-3.67	-4.15	-4.30	-4.12	-4.38	-4.28
170°	-0.60	-0.85	-0.75	-1.47	-1.60	-1.90	-2.60	-3.02	-4.10	-4.80	-5.00	-5.38	-5.52
180°	-0.40	-0.50	-0.30	-0.95	-0.95	-1.20	-1.55	-1.87	-2.45	-2.80	-2.80	-3.15	-3.08
190°	-0.80	-0.93	-0.95	-1.75	-1.85	-2.30	-3.10	-3.50	-4.60	-5.10	-5.30	-5.78	-5.78

TABLE A.7 XY Directional Response without Windscreen 3.15 kHz - 10 kHz (Continued)

Angle	Nominal Frequency												
	3.15 kHz	3.55 kHz	4 kHz	4.5 kHz	5 kHz	5.6 kHz	6.3 kHz	7.1 kHz	8 kHz	8.5 kHz	9 kHz	9.5 kHz	10 kHz
200°	-1.50	-1.83	-1.90	-2.52	-2.55	-2.80	-3.10	-3.22	-3.60	-3.90	-3.90	-4.20	-4.28
210°	-1.40	-1.33	-1.00	-1.40	-1.45	-1.80	-2.40	-3.20	-4.00	-4.50	-4.30	-4.38	-4.18
220°	-0.70	-0.73	-0.82	-1.70	-2.05	-2.07	-2.32	-2.60	-3.47	-3.95	-4.20	-4.62	-4.58
230°	-1.00	-1.23	-1.20	-1.40	-1.35	-1.90	-2.60	-3.20	-4.50	-5.10	-5.40	-5.98	-5.88
240°	-0.90	-0.73	-0.70	-1.60	-2.15	-2.50	-3.75	-4.15	-4.70	-4.70	-4.20	-4.48	-4.48
250°	-0.90	-1.33	-1.62	-2.10	-2.65	-2.70	-2.80	-2.60	-3.30	-3.80	-4.10	-4.88	-4.68
260°	-1.50	-1.43	-1.50	-2.10	-1.55	-1.70	-2.10	-2.90	-4.07	-4.30	-4.35	-4.78	-4.38
270°	-1.20	-1.23	-1.00	-1.05	-1.35	-1.70	-2.50	-3.05	-3.25	-3.40	-3.50	-3.72	-3.68
280°	-1.00	-0.60	-0.40	-1.25	-1.55	-1.75	-2.00	-2.25	-2.85	-3.00	-3.10	-3.28	-3.78
290°	-0.50	-0.43	-0.80	-1.20	-1.25	-1.35	-1.60	-1.90	-2.30	-2.55	-3.00	-2.78	-2.28
300°	-0.30	-0.73	-0.57	-1.05	-0.95	-0.90	-1.30	-1.40	-2.10	-2.00	-1.80	-2.08	-2.58
310°	-0.60	-0.47	-0.45	-0.70	-0.65	-0.75	-0.92	-1.20	-1.02	-1.65	-1.60	-1.95	-1.25
320°	-0.50	-0.27	-0.17	-0.67	-0.35	-0.40	-0.80	-0.75	-1.10	-1.12	-1.00	-1.08	-0.78
330°	-0.30	-0.23	0.00	-0.50	-0.25	-0.35	-0.30	-0.30	-0.55	-0.87	-0.50	-0.68	-0.48
340°	-0.10	-0.13	0.00	-0.22	-0.15	-0.30	-0.10	-0.15	-0.42	-0.20	-0.40	-0.32	0.02
350°	-0.10	-0.03	0.00	-0.02	-0.05	-0.10	-0.05	-0.05	-0.20	0.00	-0.10	-0.08	0.02

TABLE A.8 XY Directional Response without Windscreen 10.5 kHz - 20 kHz

Angle	Nominal Frequency											
	10.6 kHz	11.2 kHz	11.8 kHz	12.5 kHz	13.2 kHz	14 kHz	15 kHz	16 kHz	17 kHz	18 kHz	19 kHz	20 kHz
0°	0.00	0.00	0.00	0.00	0.00	0.00	0.00	0.00	0.00	0.00	0.00	0.00
10°	-0.30	-0.10	-0.32	-0.15	-0.28	-0.20	-0.22	-0.10	-0.30	-0.22	-0.15	-0.30
20°	-1.00	-0.40	-0.47	-0.45	-0.68	-0.72	-0.67	-0.70	-0.77	-0.80	-0.85	-0.92
30°	-1.20	-0.90	-0.90	-1.28	-1.20	-1.37	-1.40	-1.50	-1.50	-1.80	-1.70	-1.92
40°	-1.95	-1.20	-1.75	-1.58	-2.22	-2.07	-2.50	-2.57	-2.75	-2.70	-2.92	-3.02
50°	-2.22	-2.60	-1.90	-2.98	-2.75	-3.40	-3.42	-3.60	-3.90	-4.22	-4.30	-4.98
60°	-3.00	-2.70	-3.40	-3.38	-4.10	-4.40	-4.52	-5.00	-5.30	-5.55	-5.90	-6.79
70°	-3.50	-4.42	-3.80	-4.58	-5.18	-5.40	-5.90	-6.30	-6.70	-7.10	-7.55	-8.43
80°	-4.60	-4.20	-4.60	-5.80	-6.28	-6.70	-7.00	-7.45	-8.22	-8.70	-9.05	-9.87
90°	-5.30	-5.50	-6.05	-6.18	-7.12	-7.22	-8.50	-9.05	-9.30	-10.00	-10.40	-12.15
100°	-5.95	-5.15	-5.45	-7.15	-8.35	-9.60	-9.20	-9.65	-9.97	-11.22	-11.90	-13.49

TABLE A.8 XY Directional Response without Windscreen 10.5 kHz - 20 kHz (Continued)

Angle	Nominal Frequency											
	10.6 kHz	11.2 kHz	11.8 kHz	12.5 kHz	13.2 kHz	14 kHz	15 kHz	16 kHz	17 kHz	18 kHz	19 kHz	20 kHz
110°	-5.87	-6.90	-7.95	-8.58	-8.92	-8.70	-8.85	-9.70	-11.12	-14.00	-13.50	-14.11
120°	-5.75	-5.70	-6.02	-7.18	-8.38	-10.00	-11.60	-12.15	-13.37	-14.25	-13.20	-13.93
130°	-7.10	-7.60	-8.75	-9.60	-10.22	-10.17	-10.00	-10.27	-10.90	-11.65	-12.65	-15.06
140°	-5.67	-5.77	-6.40	-7.58	-8.52	-9.75	-11.40	-12.75	-13.52	-14.60	-15.82	-17.28
150°	-5.42	-5.90	-7.02	-8.35	-9.25	-9.70	-10.07	-10.42	-11.25	-12.30	-12.82	-14.01
160°	-5.42	-5.70	-6.40	-7.48	-8.58	-9.60	-10.32	-10.95	-11.47	-12.32	-13.15	-14.05
170°	-6.80	-7.20	-7.90	-8.98	-9.68	-10.27	-10.77	-11.30	-11.85	-12.70	-13.20	-14.13
180°	-4.30	-4.62	-5.30	-6.32	-7.08	-7.80	-8.50	-9.10	-10.00	-11.00	-12.05	-13.10
190°	-7.00	-7.10	-7.60	-8.38	-8.70	-9.10	-9.57	-10.00	-10.52	-11.40	-12.40	-13.05
200°	-5.60	-5.82	-6.45	-7.38	-8.15	-8.70	-9.20	-9.70	-10.50	-11.70	-13.30	-14.03
210°	-5.40	-6.02	-7.02	-7.68	-7.95	-8.20	-8.70	-9.30	-10.17	-11.05	-12.00	-12.41
220°	-5.50	-5.70	-6.27	-7.22	-8.30	-9.70	-10.90	-11.60	-12.50	-14.00	-15.10	-14.79
230°	-6.95	-7.30	-8.00	-8.38	-8.30	-8.20	-8.50	-8.90	-9.70	-11.10	-12.47	-13.45
240°	-5.25	-5.25	-5.70	-6.78	-8.08	-9.45	-10.40	-11.12	-12.00	-11.75	-11.77	-11.13
250°	-5.95	-6.85	-7.10	-7.42	-7.28	-7.27	-7.87	-9.10	-11.17	-12.05	-12.10	-12.24
260°	-5.35	-4.45	-5.35	-6.72	-7.68	-8.00	-7.80	-8.40	-9.00	-10.10	-11.70	-11.17
270°	-5.02	-5.20	-5.30	-5.58	-6.10	-6.60	-7.40	-7.90	-7.90	-8.90	-9.80	-10.62
280°	-4.10	-3.90	-4.20	-5.28	-5.48	-5.67	-6.15	-6.40	-6.97	-7.60	-8.50	-8.25
290°	-3.50	-3.97	-3.30	-4.00	-4.48	-4.60	-4.97	-5.40	-5.60	-6.25	-6.90	-6.88
300°	-2.70	-2.50	-3.07	-2.88	-3.58	-3.70	-3.82	-4.10	-4.30	-4.70	-5.42	-5.45
310°	-2.10	-2.30	-1.60	-2.58	-2.18	-2.82	-2.82	-3.00	-3.15	-3.47	-3.85	-3.80
320°	-1.80	-1.10	-1.50	-1.22	-1.80	-1.60	-1.95	-2.00	-2.07	-2.15	-2.60	-2.43
330°	-1.10	-0.80	-0.70	-1.08	-0.88	-1.05	-1.10	-1.10	-1.10	-1.30	-1.47	-1.30
340°	-0.95	-0.40	-0.37	-0.38	-0.48	-0.60	-0.45	-0.50	-0.50	-0.50	-0.75	-0.53
350°	-0.30	-0.10	-0.30	-0.15	-0.18	-0.10	-0.20	0.00	-0.20	-0.12	-0.10	-0.03

TABLE A.9 XZ Directional Response without Windscreen 250 Hz - 2.8 kHz

Angle	Nominal Frequency												
	250 Hz	315 Hz	400 Hz	500 Hz	630 Hz	800 Hz	1 kHz	1.25 kHz	1.6 kHz	2 kHz	2.24 kHz	2.5 kHz	2.8 kHz
0°	0.00	0.00	0.00	0.00	0.00	0.00	0.00	0.00	0.00	0.00	0.00	0.00	0.00
10°	0.03	0.00	0.05	0.05	0.03	0.00	0.00	0.02	-0.03	0.00	0.00	0.02	-0.05
20°	0.02	0.08	0.08	0.03	0.03	0.00	0.00	0.05	-0.13	-0.10	-0.05	0.05	-0.10

TABLE A.9 XZ Directional Response without Windscreen 250 Hz - 2.8 kHz (Continued)

Angle	Nominal Frequency												
	250 Hz	315 Hz	400 Hz	500 Hz	630 Hz	800 Hz	1 kHz	1.25 kHz	1.6 kHz	2 kHz	2.24 kHz	2.5 kHz	2.8 kHz
30°	-0.05	0.00	0.00	0.03	0.05	0.00	0.00	0.05	-0.25	-0.10	-0.10	0.12	-0.05
40°	0.03	0.05	0.10	0.10	0.05	0.00	0.03	0.05	-0.35	-0.20	-0.10	0.05	0.10
50°	0.05	0.05	0.08	0.05	0.05	0.03	0.10	0.05	-0.43	-0.40	-0.10	-0.05	0.10
60°	0.02	0.10	0.10	0.03	0.08	0.10	0.10	0.05	-0.37	-0.80	-0.30	-0.05	-0.12
70°	0.10	0.10	0.10	0.00	0.03	0.10	0.15	0.10	-0.33	-1.00	-0.80	-0.05	-0.12
80°	0.02	0.00	0.00	0.00	0.00	0.10	0.20	0.15	-0.30	-0.80	-1.00	-0.65	-0.25
90°	-0.05	0.00	-0.07	-0.10	-0.10	0.03	0.20	0.25	-0.27	-0.70	-0.70	-1.10	-1.12
100°	0.00	0.00	-0.05	-0.15	-0.10	0.00	0.20	0.35	-0.13	-0.80	-0.60	-0.53	-0.72
110°	-0.10	-0.10	-0.12	-0.20	-0.20	-0.10	0.00	0.25	0.13	-0.50	-0.70	-0.65	-0.47
120°	-0.18	-0.17	-0.20	-0.30	-0.22	-0.30	-0.20	0.05	0.07	-0.20	-0.20	-0.48	-0.60
130°	-0.25	-0.20	-0.25	-0.30	-0.30	-0.30	-0.30	-0.15	-0.30	-0.40	-0.20	0.05	0.10
140°	-0.28	-0.27	-0.27	-0.30	-0.30	-0.30	-0.30	-0.25	-0.53	-1.00	-0.80	-0.48	-0.27
150°	-0.30	-0.30	-0.30	-0.25	-0.20	-0.32	-0.30	-0.15	-0.45	-1.10	-1.10	-1.15	-1.10
160°	-0.30	-0.30	-0.27	-0.20	-0.10	-0.30	-0.27	-0.03	-0.27	-0.80	-0.80	-0.85	-0.90
170°	-0.35	-0.30	-0.32	-0.12	-0.07	-0.15	-0.20	-0.03	0.07	-0.60	-0.50	-0.35	-0.25
180°	-0.35	-0.40	-0.32	-0.10	-0.10	-0.10	-0.20	-0.05	0.25	-0.50	-0.40	0.05	0.10
190°	-0.42	-0.40	-0.40	-0.17	-0.10	-0.20	-0.30	-0.05	0.17	-0.70	-0.40	-0.30	-0.25
200°	-0.45	-0.40	-0.40	-0.20	-0.12	-0.30	-0.30	-0.05	-0.33	-0.80	-0.70	-0.95	-0.90
210°	-0.38	-0.40	-0.35	-0.30	-0.25	-0.40	-0.30	-0.25	-0.43	-1.20	-1.20	-1.25	-1.30
220°	-0.42	-0.40	-0.42	-0.40	-0.30	-0.40	-0.40	-0.35	-0.57	-1.00	-0.90	-0.65	-0.37
230°	-0.40	-0.40	-0.40	-0.30	-0.30	-0.40	-0.40	-0.25	-0.33	-0.50	-0.30	-0.05	0.20
240°	-0.38	-0.37	-0.40	-0.30	-0.30	-0.40	-0.30	-0.05	0.07	-0.30	-0.20	-0.30	-0.37
250°	-0.38	-0.40	-0.40	-0.30	-0.25	-0.30	-0.15	0.15	0.17	-0.40	-0.50	-0.55	-0.50
260°	-0.28	-0.30	-0.30	-0.25	-0.20	-0.17	0.00	0.25	0.03	-0.60	-0.70	-0.75	-0.90
270°	-0.25	-0.27	-0.30	-0.17	-0.10	-0.10	0.05	0.25	-0.13	-0.70	-0.80	-1.15	-1.10
280°	-0.28	-0.20	-0.20	-0.10	-0.10	0.00	0.00	0.15	-0.23	-0.95	-1.10	-0.75	-0.30
290°	-0.22	-0.15	-0.17	-0.10	0.00	0.00	0.00	0.05	-0.33	-1.00	-0.80	-0.15	0.00
300°	-0.18	-0.10	-0.15	-0.02	0.00	0.00	0.00	0.05	-0.43	-0.80	-0.37	-0.05	0.00
310°	-0.12	-0.10	-0.10	0.00	0.00	0.00	0.00	0.05	-0.50	-0.40	-0.20	0.00	0.05
320°	-0.08	0.00	-0.10	0.00	0.00	-0.10	0.00	-0.03	-0.40	-0.20	-0.10	0.05	-0.02
330°	-0.12	-0.02	-0.10	0.00	0.00	-0.10	0.00	-0.05	-0.30	-0.10	-0.10	0.05	-0.10
340°	-0.08	0.00	-0.02	0.00	0.00	-0.10	0.00	-0.05	-0.13	-0.10	-0.10	-0.05	-0.10

TABLE A.9 XZ Directional Response without Windscreen 250 Hz - 2.8 kHz (Continued)

Angle	Nominal Frequency												
	250 Hz	315 Hz	400 Hz	500 Hz	630 Hz	800 Hz	1 kHz	1.25 kHz	1.6 kHz	2 kHz	2.24 kHz	2.5 kHz	2.8 kHz
350°	-0.08	-0.07	-0.05	0.00	0.00	-0.10	0.00	-0.05	-0.05	-0.10	-0.07	-0.05	-0.10

TABLE A.10 XZ Directional Response without Windscreen 3.15 kHz - 10 kHz

Angle	Nominal Frequency												
	3.15 kHz	3.55 kHz	4 kHz	4.5 kHz	5 kHz	5.6 kHz	6.3 kHz	7.1 kHz	8 kHz	8.5 kHz	9 kHz	9.5 kHz	10 kHz
0°	0.00	0.00	0.00	0.00	0.00	0.00	0.00	0.00	0.00	0.00	0.00	0.00	0.00
10°	0.00	-0.05	0.00	-0.10	0.00	-0.07	0.00	0.00	-0.15	0.00	-0.03	0.00	-0.02
20°	0.00	-0.10	0.00	-0.32	0.05	-0.30	0.03	-0.30	-0.43	-0.37	-0.27	-0.30	-0.17
30°	-0.20	-0.15	-0.05	-0.60	0.10	-0.65	-0.10	-0.80	-0.53	-1.00	-0.33	-0.75	-0.47
40°	-0.57	-0.12	-0.25	-0.67	-0.30	-0.60	-0.70	-0.60	-0.83	-1.00	-1.33	-0.92	-0.80
50°	-0.60	-0.47	-0.35	-0.70	-1.00	-0.50	-1.30	-1.00	-1.70	-1.60	-1.33	-2.10	-1.47
60°	-0.30	-1.00	-0.35	-1.02	-1.00	-1.20	-1.10	-1.90	-1.43	-2.40	-2.03	-2.10	-2.20
70°	-0.50	-0.50	-1.20	-1.15	-1.12	-1.40	-1.70	-1.60	-2.75	-2.77	-2.23	-3.25	-2.80
80°	-0.70	-0.72	-0.45	-1.75	-1.40	-1.65	-1.92	-2.80	-2.50	-3.25	-3.53	-3.85	-3.05
90°	-0.80	-0.80	-1.05	-1.10	-1.80	-2.10	-2.40	-2.42	-3.73	-4.20	-3.30	-3.70	-3.80
100°	-1.80	-1.50	-0.85	-1.60	-1.60	-1.50	-3.00	-3.20	-3.73	-3.70	-3.77	-4.62	-5.50
110°	-0.80	-1.60	-2.25	-2.40	-1.70	-2.40	-2.30	-2.50	-4.35	-4.80	-4.93	-5.20	-4.60
120°	-1.10	-1.00	-0.78	-1.72	-3.00	-3.10	-2.70	-3.55	-4.03	-3.70	-3.63	-4.40	-5.10
130°	-0.52	-1.10	-1.53	-1.90	-1.40	-1.70	-3.15	-4.52	-4.93	-4.77	-4.73	-5.35	-5.80
140°	-0.40	-0.30	-0.15	-1.07	-1.70	-2.50	-3.00	-2.90	-2.93	-3.32	-4.15	-5.20	-6.25
150°	-1.70	-1.50	-1.35	-1.40	-1.10	-1.10	-1.40	-2.02	-3.33	-4.20	-4.70	-5.20	-5.20
160°	-1.60	-1.80	-2.08	-3.10	-3.22	-3.70	-4.00	-4.10	-4.23	-4.20	-3.80	-3.90	-3.30
170°	-0.70	-0.90	-0.80	-1.75	-1.70	-2.50	-3.20	-3.90	-5.23	-5.90	-6.33	-7.00	-7.50
180°	-0.40	-0.40	-0.05	-0.90	-0.90	-1.00	-1.40	-1.90	-2.40	-2.70	-2.87	-3.10	-3.10
190°	-0.80	-0.70	-0.85	-1.60	-1.70	-2.00	-3.00	-3.60	-4.87	-5.40	-5.83	-6.40	-6.80
200°	-1.50	-2.00	-1.98	-3.17	-3.40	-3.77	-4.30	-4.50	-4.23	-4.40	-3.93	-4.00	-3.70
210°	-1.70	-1.70	-1.35	-1.70	-1.27	-1.10	-1.30	-1.70	-2.83	-3.50	-4.23	-4.80	-5.30
220°	-0.50	-0.30	-0.15	-0.80	-1.30	-1.95	-2.70	-3.00	-3.55	-4.30	-4.93	-5.90	-6.40
230°	-0.40	-0.90	-1.15	-1.70	-1.60	-2.12	-3.72	-4.90	-4.67	-4.90	-4.93	-5.25	-4.80
240°	-1.00	-1.00	-1.05	-2.10	-3.20	-3.10	-2.90	-3.42	-3.23	-3.70	-4.63	-5.40	-5.20
250°	-1.10	-1.80	-2.35	-2.40	-1.72	-2.10	-2.00	-3.20	-3.73	-4.50	-5.15	-4.80	-4.00

TABLE A.10 XZ Directional Response without Windscreen 3.15 kHz - 10 kHz (Continued)

Angle	Nominal Frequency												
	3.15 kHz	3.55 kHz	4 kHz	4.5 kHz	5 kHz	5.6 kHz	6.3 kHz	7.1 kHz	8 kHz	8.5 kHz	9 kHz	9.5 kHz	10 kHz
260°	-1.80	-1.50	-0.85	-1.50	-1.30	-1.90	-2.60	-3.40	-3.03	-3.50	-4.33	-4.50	-5.10
270°	-0.90	-0.70	-0.78	-1.10	-1.90	-1.80	-2.67	-2.20	-3.10	-3.75	-3.83	-3.60	-3.50
280°	-0.50	-0.70	-0.60	-1.62	-1.40	-1.70	-2.17	-2.15	-2.63	-2.80	-3.03	-3.90	-3.70
290°	-0.50	-0.70	-0.88	-1.20	-1.10	-1.40	-1.50	-1.85	-2.43	-2.90	-2.53	-2.50	-2.30
300°	-0.50	-0.75	-0.50	-1.15	-0.90	-0.82	-1.10	-1.70	-1.90	-1.90	-1.73	-2.72	-2.10
310°	-0.60	-0.45	-0.50	-0.67	-0.70	-0.90	-1.10	-1.20	-1.13	-1.60	-1.73	-1.50	-1.10
320°	-0.40	-0.40	-0.13	-0.80	-0.30	-0.30	-0.70	-0.70	-1.15	-1.40	-0.93	-0.80	-1.50
330°	-0.20	-0.30	0.00	-0.50	-0.40	-0.32	-0.40	-0.30	-0.80	-0.57	-0.33	-1.15	-0.30
340°	-0.10	-0.15	-0.05	-0.20	-0.20	-0.40	-0.20	-0.20	-0.23	-0.22	-0.53	-0.30	0.10
350°	-0.10	-0.10	-0.05	-0.07	0.00	-0.10	-0.10	-0.10	-0.07	0.00	-0.23	0.00	0.10

TABLE A.11 XZ Directional Response without Windscreen 10.5 kHz - 20 kHz

Angle	Nominal Frequency											
	10.6 kHz	11.2 kHz	11.8 kHz	12.5 kHz	13.2 kHz	14 kHz	15 kHz	16 kHz	17 kHz	18 kHz	19 kHz	20 kHz
0°	0.00	0.00	0.00	0.00	0.00	0.00	0.00	0.00	0.00	0.00	0.00	0.00
10°	-0.20	-0.15	-0.30	-0.25	-0.10	-0.30	-0.08	0.00	0.00	-0.30	-0.12	-0.10
20°	-0.90	-0.15	-0.65	-0.20	-0.50	-0.67	-0.50	-0.70	-0.62	-0.48	-0.70	-0.63
30°	-1.12	-0.65	-1.02	-1.00	-1.20	-0.90	-1.45	-1.07	-1.10	-1.28	-1.72	-1.35
40°	-1.90	-1.30	-1.30	-1.42	-1.70	-1.87	-1.75	-2.40	-1.90	-2.20	-2.80	-2.95
50°	-2.00	-2.45	-1.90	-2.65	-2.32	-3.15	-2.95	-3.20	-3.60	-3.50	-4.10	-4.23
60°	-3.40	-2.25	-3.10	-3.22	-3.90	-3.80	-3.90	-4.30	-4.35	-4.68	-5.70	-5.69
70°	-3.30	-3.85	-4.05	-4.17	-4.70	-4.57	-5.55	-5.60	-6.00	-6.50	-7.25	-7.16
80°	-4.40	-4.25	-5.00	-4.80	-6.05	-5.90	-6.15	-7.10	-7.15	-8.28	-8.30	-9.07
90°	-5.40	-5.55	-4.77	-5.97	-7.20	-6.50	-7.25	-8.50	-8.20	-9.30	-10.10	-10.44
100°	-5.35	-4.95	-5.60	-7.32	-7.92	-7.27	-8.05	-9.35	-9.77	-9.58	-12.05	-11.98
110°	-5.25	-5.55	-6.92	-8.32	-7.67	-8.20	-8.45	-9.90	-11.40	-10.60	-12.00	-14.12
120°	-6.50	-6.95	-7.27	-7.75	-8.40	-8.10	-9.05	-11.00	-11.80	-12.08	-12.40	-12.42
130°	-6.40	-6.23	-6.37	-6.80	-7.55	-8.80	-10.40	-11.40	-11.75	-13.08	-13.25	-12.60
140°	-7.20	-7.05	-7.27	-8.20	-9.10	-10.40	-10.90	-11.37	-11.50	-11.48	-12.00	-12.32
150°	-5.80	-5.80	-6.32	-6.70	-7.20	-7.70	-8.55	-9.30	-10.40	-11.68	-13.27	-13.80
160°	-4.10	-4.25	-4.82	-5.77	-6.50	-7.40	-8.15	-9.07	-10.02	-11.65	-12.87	-13.64

TABLE A.11 XZ Directional Response without Windscreen 10.5 kHz - 20 kHz (Continued)

Angle	Nominal Frequency											
	10.6 kHz	11.2 kHz	11.8 kHz	12.5 kHz	13.2 kHz	14 kHz	15 kHz	16 kHz	17 kHz	18 kHz	19 kHz	20 kHz
170°	-8.97	-9.58	-10.10	-11.40	-12.30	-13.35	-14.05	-14.60	-15.02	-15.88	-16.25	-16.07
180°	-4.20	-4.55	-5.20	-6.22	-7.00	-7.77	-8.55	-9.20	-10.10	-11.12	-12.12	-13.46
190°	-8.40	-9.53	-10.95	-13.17	-14.57	-15.80	-17.28	-18.30	-18.40	-17.68	-17.10	-16.85
200°	-4.45	-4.65	-5.15	-5.90	-6.72	-7.70	-8.75	-9.70	-10.87	-11.95	-12.60	-13.27
210°	-6.30	-6.05	-5.80	-6.10	-6.92	-8.20	-9.75	-11.70	-13.15	-13.68	-13.82	-14.94
220°	-7.25	-6.95	-7.20	-8.50	-10.12	-11.07	-11.25	-11.50	-12.47	-13.98	-13.70	-14.07
230°	-5.50	-6.25	-7.45	-8.37	-8.30	-9.07	-10.15	-11.25	-12.30	-14.38	-14.70	-16.27
240°	-6.30	-6.50	-6.37	-7.60	-9.50	-10.10	-10.45	-11.00	-11.60	-13.28	-13.20	-15.40
250°	-5.90	-6.65	-7.32	-7.00	-7.85	-9.17	-9.55	-11.25	-11.50	-12.00	-12.80	-13.94
260°	-5.40	-5.08	-5.60	-7.70	-7.85	-8.10	-8.45	-10.00	-10.60	-11.38	-11.35	-13.07
270°	-5.30	-6.05	-5.10	-5.30	-7.50	-7.50	-7.85	-8.50	-9.55	-10.18	-10.40	-11.88
280°	-3.80	-3.65	-5.90	-4.90	-5.65	-6.52	-7.05	-7.10	-8.30	-8.48	-9.10	-10.08
290°	-4.70	-3.35	-3.40	-4.82	-4.52	-5.10	-6.15	-5.90	-6.70	-7.28	-7.35	-8.83
300°	-2.55	-3.15	-3.20	-3.07	-4.30	-3.77	-4.68	-5.00	-4.90	-5.68	-5.80	-6.75
310°	-2.90	-1.85	-1.95	-2.77	-2.50	-3.20	-3.25	-3.50	-3.70	-4.08	-4.40	-4.72
320°	-1.50	-1.48	-1.67	-1.60	-1.90	-1.90	-2.35	-2.20	-2.52	-2.68	-2.90	-3.45
330°	-0.90	-1.20	-0.47	-1.30	-0.80	-1.30	-1.05	-1.50	-1.50	-1.78	-1.80	-1.87
340°	-1.40	-0.03	-0.80	-0.30	-0.80	-0.50	-0.95	-0.70	-0.85	-0.58	-0.90	-0.80
350°	-0.50	0.05	-0.42	0.10	-0.22	0.00	-0.25	-0.30	-0.35	-0.28	-0.30	-0.22

Appendix **B** Measuring Sound Using IEC 61672-1

This appendix presents information for assessing the sound level meter functionality of the Larson Davis SoundExpert 821/721 according to IEC 61672-1 Edition 2.0 2013-09.

For all periodic testing to IEC 61672-3, microphone correction filters shall be set to FF:FF. The appropriate corrections and filter selections are described in this appendix, see **e) Required Frequency Response and Corrections**.

B.1 IEC 61672-1 Section 9.3

a) Reference Sound Pressure Level

The reference sound pressure level is 114 dB re 20 μ Pa.

b) Reference Level Range

There is a single level range.

c) Microphone Reference Point

The microphone reference point is the center of the diaphragm of the 377B02 microphone.

d) Multi-Frequency Calibrator and Electrostatic Actuator Corrections

These tables list A-weighted microphone adjustments for the 821/721 with PRM821/377B02 for periodic measurements.

e) Required Frequency Response and Corrections

Frequency response and corrections for the 721 are identical to those shown for 821 in the following tables and figures, which describe the frequency response and corrections required by IEC61672-1, Section 9.3:

- **Table B.1 "821 with PRM821/377B02 Average Frequency Responses and Corrections, Required by IEC 61672-1"**
- **Table B.2 "821 with PRM821/377B02 Random Incidence Responses and Corrections, Required by IEC 61672-1"**
- **Table B.3 "Directional Response (from 0° to 90°) of 3 ½-inch Windscreen"**
- **Table B.4 "Directional Response (from 100° to 180°) of 3 ½-inch Windscreen"**
- **Table B.5 "Test, Filter, and EPS2116 Correction Description"**
- **Table B.6 "Effects of EPS2116 Environmental Shroud"**
- **Figure B-1 Windscreen Direction**
- **Figure B-2 Graph of the EPS2116 Environmental Shroud Random Incidence Response**

TABLE B.1 821 with PRM821/377B02 Average Frequency Responses and Corrections, Required by IEC 61672-1

Frequency	0° Free Field Response	Effect of WS001 Windscreen	0° Free Field, 821 with WS001 Windscreen	Expanded uncertainty of Corrections @95%
Hz	dB	dB	dB	dB
63	0.00	-0.05	-0.05	0.25
79	0.00	-0.05	-0.05	0.25
100	0.00	-0.05	-0.05	0.25
126	0.00	-0.05	-0.05	0.25
159	0.00	-0.05	-0.05	0.25
200	0.03	-0.05	-0.02	0.25
251	0.04	-0.05	-0.01	0.25
316	0.04	-0.02	0.02	0.25
398	0.09	-0.05	0.04	0.25
501	0.13	0.05	0.19	0.25
631	0.20	0.02	0.22	0.25
794	0.06	0.11	0.18	0.25
1000	0.00	0.14	0.14	0.25
1059	-0.06	0.19	0.13	0.25
1122	-0.15	0.24	0.08	0.25
1189	-0.14	0.17	0.03	0.25
1259	-0.09	0.22	0.13	0.25
1334	-0.24	0.32	0.08	0.25
1413	-0.11	0.24	0.14	0.25
1496	-0.15	0.34	0.18	0.25
1585	0.10	0.42	0.52	0.25
1679	0.05	0.44	0.48	0.25
1778	0.37	0.50	0.87	0.25
1884	0.43	0.49	0.91	0.25
1995	0.40	0.59	0.99	0.25
2113	0.33	0.63	0.96	0.35

TABLE B.1 821 with PRM821/377B02 Average Frequency Responses and Corrections, Required by IEC 61672-1 (Continued)

Frequency	0° Free Field Response	Effect of WS001 Windscreen	0° Free Field, 821 with WS001 Windscreen	Expanded uncertainty of Corrections @95%
Hz	dB	dB	dB	dB
2239	0.32	0.60	0.91	0.35
2371	0.28	0.74	1.02	0.35
2512	0.17	0.71	0.88	0.35
2661	0.15	0.74	0.89	0.35
2818	0.06	0.76	0.82	0.35
2985	0.30	0.75	1.05	0.35
3162	0.37	0.64	1.00	0.35
3350	0.27	0.61	0.87	0.35
3548	0.31	0.47	0.78	0.35
3758	0.31	0.31	0.62	0.35
3981	0.21	0.19	0.40	0.35
4217	0.44	0.09	0.52	0.45
4467	0.59	0.04	0.62	0.45
4732	0.55	-0.19	0.36	0.45
5012	0.47	-0.21	0.26	0.45
5309	0.18	-0.03	0.15	0.45
5623	0.45	0.06	0.52	0.45
5957	0.71	0.15	0.86	0.45
6310	0.50	0.11	0.61	0.45
6683	0.37	0.15	0.52	0.45
7079	0.48	0.09	0.56	0.45
7499	0.32	-0.11	0.21	0.45
7943	0.63	-0.26	0.37	0.45
8414	0.73	-0.54	0.20	0.55
8913	0.49	-0.35	0.14	0.55
9441	0.55	-0.35	0.20	0.55
10000	-0.08	-0.29	-0.37	0.55

TABLE B.1 821 with PRM821/377B02 Average Frequency Responses and Corrections, Required by IEC 61672-1 (Continued)

Frequency	0° Free Field Response	Effect of WS001 Windscreen	0° Free Field, 821 with WS001 Windscreen	Expanded uncertainty of Corrections @95%
Hz	dB	dB	dB	dB
10593	0.74	-0.19	0.55	0.55
11220	0.13	-0.83	-0.70	0.55
11885	0.30	-0.53	-0.24	0.55
12589	0.39	-1.05	-0.66	0.55
13335	0.64	-0.70	-0.07	1
14125	0.76	-0.71	0.04	1
14962	0.91	-0.98	-0.07	1
15849	0.96	-1.40	-0.44	1
16788	0.91	-1.10	-0.19	1
17783	0.87	-1.13	-0.25	1
18836	0.73	-1.55	-0.82	1
19953	0.27	-1.58	-1.31	1

Note: Corrected results that account for acoustic effects on an electrical test signal shall be obtained by adding the appropriate response values to the measured level. FF:FF microphone correction filter shall be enabled for test configuration.

TABLE B.2 821 with PRM821/377B02 Random Incidence Responses and Corrections, Required by IEC 61672-1

Frequency	Random Incidence Response	Effect of WS001 Windscreen on Random Response	Random Response, 821 with WS001 Windscreen	Expanded uncertainty of Corrections @95%
Hz	dB	dB	dB	dB
63	0.00	-0.06	-0.06	0.25
79	0.00	-0.06	-0.06	0.25
100	0.00	-0.06	-0.06	0.25
126	0.00	-0.06	-0.06	0.25
159	0.00	-0.06	-0.06	0.25
200	-0.01	-0.05	-0.06	0.25
251	-0.02	-0.05	-0.07	0.25

**TABLE B.2 821 with PRM821/377B02 Random Incidence Responses and Corrections,
Required by IEC 61672-1 (Continued)**

Frequency	Random Incidence Response	Effect of WS001 Windscreen on Random Response	Random Response, 821 with WS001 Windscreen	Expanded uncertainty of Corrections @95%
Hz	dB	dB	dB	dB
316	-0.06	-0.05	-0.11	0.25
398	-0.03	-0.04	-0.07	0.25
501	0.05	0.00	0.05	0.25
631	0.11	0.00	0.11	0.25
794	0.00	0.05	0.05	0.25
1000	0.00	0.10	0.10	0.25
1059	0.01	0.10	0.11	0.25
1122	-0.02	0.15	0.12	0.25
1189	-0.01	0.15	0.14	0.25
1259	0.02	0.16	0.19	0.25
1334	-0.12	0.22	0.10	0.25
1413	-0.02	0.23	0.20	0.25
1496	-0.01	0.23	0.22	0.25
1585	-0.03	0.32	0.29	0.25
1679	-0.08	0.31	0.23	0.25
1778	-0.12	0.40	0.28	0.25
1884	-0.07	0.41	0.34	0.25
1995	-0.05	0.48	0.43	0.25
2113	-0.13	0.52	0.39	0.35
2239	-0.14	0.52	0.38	0.35
2371	-0.17	0.59	0.42	0.35
2512	-0.17	0.63	0.45	0.35
2661	-0.17	0.64	0.47	0.35
2818	-0.21	0.67	0.46	0.35
2985	-0.28	0.63	0.35	0.35
3162	-0.32	0.57	0.25	0.35
3350	-0.35	0.51	0.16	0.35

**TABLE B.2 821 with PRM821/377B02 Random Incidence Responses and Corrections,
Required by IEC 61672-1 (Continued)**

Frequency	Random Incidence Response	Effect of WS001 Windscreen on Random Response	Random Response, 821 with WS001 Windscreen	Expanded uncertainty of Corrections @95%
Hz	dB	dB	dB	dB
3548	-0.41	0.37	-0.04	0.35
3758	-0.46	0.25	-0.21	0.35
3981	-0.52	0.12	-0.40	0.35
4217	-0.53	-0.02	-0.55	0.45
4467	-0.63	-0.14	-0.77	0.45
4732	-0.76	-0.34	-1.10	0.45
5012	-0.81	-0.39	-1.20	0.45
5309	-0.97	-0.38	-1.36	0.45
5623	-1.01	-0.35	-1.36	0.45
5957	-1.15	-0.26	-1.41	0.45
6310	-1.34	-0.14	-1.49	0.45
6683	-1.52	-0.08	-1.60	0.45
7079	-1.64	-0.03	-1.67	0.45
7499	-1.85	-0.15	-1.99	0.45
7943	-1.97	-0.43	-2.40	0.45
8414	-2.14	-0.54	-2.67	0.55
8913	-2.44	-0.70	-3.14	0.55
9441	-2.69	-0.70	-3.38	0.55
10000	-3.09	-0.60	-3.68	0.55
10593	-3.30	-0.55	-3.85	0.55
11220	-3.62	-0.66	-4.28	0.55
11885	-3.74	-0.91	-4.65	0.55
12589	-4.02	-1.18	-5.20	0.55
13335	-4.22	-1.09	-5.31	1
14125	-4.35	-1.00	-5.35	1
14962	-4.50	-1.23	-5.74	1
15849	-4.79	-1.49	-6.28	1

TABLE B.2 821 with PRM821/377B02 Random Incidence Responses and Corrections, Required by IEC 61672-1 (Continued)

Frequency	Random Incidence Response	Effect of WS001 Windscreen on Random Response	Random Response, 821 with WS001 Windscreen	Expanded uncertainty of Corrections @95%
Hz	dB	dB	dB	dB
16788	-5.05	-1.54	-6.59	1
17783	-5.50	-1.51	-7.00	1
18836	-6.02	-1.76	-7.78	1
19953	-6.58	-1.88	-8.46	1

Note: Corrected results that account for acoustic effects on an electrical test signal shall be obtained by adding the appropriate response values to the measured level. FF:RI microphone correction filter shall be enabled for test configuration.

TABLE B.3 Directional Response (from 0° to 90°) of 3 ½-inch Windscreen

Frequency (Hz)	Angle from Reference Direction (Degrees) ¹									
	0°	10°	20°	30°	40°	50°	60°	70°	80°	90°
63	-0.06	-0.10	-0.05	-0.05	-0.08	-0.07	-0.08	-0.07	-0.08	-0.08
79	-0.06	-0.10	-0.05	-0.05	-0.08	-0.07	-0.08	-0.07	-0.08	-0.08
100	-0.06	-0.10	-0.05	-0.05	-0.08	-0.07	-0.08	-0.07	-0.08	-0.08
126	-0.06	-0.10	-0.05	-0.05	-0.08	-0.07	-0.08	-0.07	-0.08	-0.08
159	-0.06	-0.10	-0.05	-0.05	-0.08	-0.07	-0.08	-0.07	-0.08	-0.08
200	-0.06	-0.15	-0.05	-0.05	-0.10	-0.08	-0.10	-0.07	-0.10	-0.10
251	-0.05	-0.15	-0.05	-0.05	-0.10	-0.08	-0.10	-0.07	-0.10	-0.10
316	-0.02	-0.10	-0.10	-0.10	-0.13	-0.10	-0.10	-0.10	-0.10	-0.07
398	-0.05	-0.10	-0.07	-0.10	-0.13	-0.13	-0.10	-0.12	-0.10	-0.10
501	0.05	0.00	0.00	0.00	-0.03	-0.03	-0.05	-0.05	-0.10	-0.10
631	0.02	-0.05	-0.08	-0.03	-0.10	-0.05	-0.03	-0.08	-0.10	-0.07
794	0.11	0.07	0.00	0.05	0.00	0.00	0.00	0.00	0.00	0.00
1000	0.14	0.10	0.10	0.10	0.07	0.00	0.00	0.10	0.07	0.03
1059	0.19	0.10	0.00	0.00	0.00	0.00	0.03	0.00	0.00	0.00
1122	0.24	0.07	0.02	0.00	0.10	0.10	0.10	0.10	0.02	0.10
1189	0.17	0.18	0.20	0.20	0.10	0.10	0.10	0.00	0.00	0.10

TABLE B.3 Directional Response (from 0° to 90°) of 3 ½-inch Windscreen (Continued)

Frequency (Hz)	Angle from Reference Direction (Degrees) ¹									
	0°	10°	20°	30°	40°	50°	60°	70°	80°	90°
1259	0.22	0.17	0.12	0.10	0.10	0.10	0.05	0.08	0.10	0.00
1334	0.32	0.30	0.20	0.20	0.20	0.10	0.20	0.17	0.20	0.15
1413	0.24	0.20	0.20	0.27	0.20	0.20	0.18	0.15	0.20	0.10
1496	0.34	0.30	0.20	0.27	0.20	0.25	0.20	0.10	0.12	0.10
1585	0.42	0.30	0.30	0.32	0.30	0.25	0.28	0.23	0.20	0.20
1679	0.44	0.35	0.38	0.30	0.25	0.20	0.13	0.23	0.20	0.20
1778	0.50	0.40	0.40	0.40	0.40	0.37	0.30	0.28	0.30	0.30
1884	0.49	0.40	0.40	0.40	0.40	0.40	0.30	0.30	0.30	0.30
1995	0.59	0.50	0.50	0.42	0.50	0.45	0.40	0.40	0.30	0.30
2113	0.63	0.53	0.52	0.58	0.50	0.50	0.40	0.40	0.40	0.30
2239	0.60	0.50	0.60	0.50	0.57	0.50	0.40	0.40	0.40	0.30
2371	0.74	0.60	0.60	0.60	0.50	0.50	0.50	0.50	0.50	0.48
2512	0.71	0.70	0.60	0.50	0.50	0.60	0.45	0.50	0.50	0.50
2661	0.74	0.60	0.63	0.60	0.60	0.50	0.52	0.50	0.45	0.45
2818	0.76	0.67	0.68	0.68	0.60	0.55	0.60	0.57	0.50	0.48
2985	0.75	0.70	0.60	0.62	0.60	0.55	0.50	0.50	0.45	0.43
3162	0.64	0.50	0.50	0.50	0.50	0.40	0.50	0.40	0.40	0.40
3350	0.61	0.50	0.50	0.45	0.50	0.40	0.40	0.40	0.40	0.33
3548	0.47	0.35	0.40	0.38	0.30	0.30	0.23	0.25	0.20	0.20
3758	0.31	0.25	0.22	0.23	0.20	0.17	0.10	0.10	0.10	0.10
3981	0.19	0.10	0.10	0.10	0.10	0.07	0.00	-0.02	0.00	0.00
4217	0.09	0.08	0.00	0.00	-0.10	-0.10	-0.10	-0.17	-0.15	-0.20
4467	0.04	-0.02	-0.07	-0.07	-0.15	-0.12	-0.17	-0.30	-0.32	-0.30
4732	-0.19	-0.20	-0.20	-0.23	-0.33	-0.33	-0.40	-0.40	-0.50	-0.50
5012	-0.21	-0.20	-0.25	-0.30	-0.30	-0.37	-0.40	-0.40	-0.60	-0.53
5309	-0.03	0.00	-0.03	-0.17	-0.22	-0.30	-0.30	-0.40	-0.50	-0.55
5623	0.06	0.10	0.03	-0.05	-0.17	-0.22	-0.38	-0.35	-0.47	-0.55
5957	0.15	0.10	0.03	-0.03	-0.10	-0.20	-0.30	-0.40	-0.48	-0.48

TABLE B.3 Directional Response (from 0° to 90°) of 3 ½-inch Windscreen (Continued)

Frequency (Hz)	Angle from Reference Direction (Degrees) ¹									
	0°	10°	20°	30°	40°	50°	60°	70°	80°	90°
6310	0.11	0.00	0.05	0.00	0.00	-0.08	-0.15	-0.27	-0.30	-0.40
6683	0.15	0.08	0.05	0.02	0.03	-0.10	-0.15	-0.15	-0.25	-0.38
7079	0.09	0.00	0.00	0.05	0.00	0.00	-0.10	-0.15	-0.10	-0.10
7499	-0.11	-0.20	-0.20	-0.20	-0.20	-0.10	-0.20	-0.20	-0.27	-0.20
7943	-0.26	-0.33	-0.33	-0.40	-0.45	-0.50	-0.45	-0.40	-0.45	-0.40
8414	-0.54	-0.50	-0.50	-0.43	-0.43	-0.50	-0.50	-0.55	-0.60	-0.50
8913	-0.35	-0.25	-0.30	-0.40	-0.48	-0.55	-0.68	-0.60	-0.60	-0.65
9441	-0.35	-0.22	-0.20	-0.30	-0.40	-0.50	-0.63	-0.53	-0.70	-0.70
10000	-0.29	-0.30	-0.30	-0.40	-0.40	-0.40	-0.60	-0.70	-0.80	-0.80
10593	-0.19	-0.30	-0.30	-0.35	-0.45	-0.58	-0.60	-0.80	-0.70	-0.80
11220	-0.83	-0.92	-0.80	-0.70	-0.60	-0.52	-0.70	-0.68	-0.72	-0.85
11885	-0.53	-0.58	-0.73	-0.87	-0.78	-0.80	-0.90	-0.80	-1.00	-0.98
12589	-1.05	-1.03	-1.03	-1.00	-1.10	-1.07	-1.10	-1.20	-1.28	-1.42
13335	-0.70	-0.65	-0.70	-0.88	-0.95	-1.03	-1.12	-1.15	-1.20	-1.35
14125	-0.71	-0.80	-0.78	-0.83	-0.93	-0.97	-1.05	-1.17	-1.20	-1.48
14962	-0.98	-1.08	-1.03	-1.02	-1.00	-1.08	-1.10	-1.10	-1.47	-1.47
15849	-1.40	-1.40	-1.40	-1.30	-1.23	-1.40	-1.22	-1.50	-1.75	-1.70
16788	-1.10	-1.00	-1.10	-1.20	-1.15	-1.22	-1.30	-1.47	-1.70	-1.60
17783	-1.13	-1.12	-1.10	-1.20	-1.30	-1.38	-1.55	-1.80	-1.90	-1.90
18836	-1.55	-1.65	-1.53	-1.42	-1.52	-1.57	-1.77	-1.90	-2.05	-2.20
19953	-1.58	-1.93	-1.73	-1.73	-2.13	-1.75	-1.69	-2.47	-2.30	-2.62

1. Note: These values represent the typical effect of the WS001 windscreen on the acoustic response of the 821/721 sound level meter. They may be subtracted from a measured value to correct for the windscreen effect.

TABLE B.4 Directional Response (from 100° to 180°) of 3 ½-inch Windscreen

Frequency (Hz)	Angle from Reference Direction (Degrees) ¹								
	100°	110°	120°	130°	140°	150°	160°	170°	180°
63	-0.12	-0.08	-0.08	-0.08	-0.07	-0.06	-0.08	-0.06	-0.10
79	-0.12	-0.08	-0.08	-0.08	-0.07	-0.06	-0.08	-0.06	-0.10

TABLE B.4 Directional Response (from 100° to 180°) of 3 ½-inch Windscreen (Continued)

Frequency (Hz)	Angle from Reference Direction (Degrees) ¹								
	100°	110°	120°	130°	140°	150°	160°	170°	180°
100	-0.12	-0.08	-0.08	-0.08	-0.07	-0.06	-0.08	-0.06	-0.10
126	-0.12	-0.08	-0.08	-0.08	-0.07	-0.06	-0.08	-0.06	-0.10
159	-0.12	-0.08	-0.08	-0.08	-0.07	-0.06	-0.08	-0.06	-0.10
200	-0.15	-0.10	-0.10	-0.10	-0.08	-0.07	-0.10	-0.08	-0.12
251	-0.15	-0.10	-0.10	-0.10	-0.08	-0.07	-0.10	-0.08	-0.12
316	-0.07	-0.10	-0.12	-0.05	-0.10	-0.07	-0.12	-0.10	-0.13
398	-0.13	-0.10	-0.05	-0.10	-0.10	-0.10	-0.08	-0.08	-0.13
501	-0.10	-0.10	-0.13	-0.10	-0.10	-0.12	-0.18	-0.10	-0.08
631	-0.08	-0.10	-0.12	-0.02	-0.05	-0.10	-0.10	-0.05	0.00
794	0.00	0.00	0.00	0.00	0.00	0.00	0.00	0.00	0.00
1000	0.00	0.00	0.00	0.00	0.07	0.10	0.10	0.00	0.02
1059	0.00	0.00	0.00	0.07	0.03	0.00	0.10	0.00	0.03
1122	0.00	0.03	0.10	0.10	0.10	0.05	0.08	0.10	0.03
1189	0.00	0.10	0.10	0.02	0.00	0.00	0.10	0.10	0.03
1259	0.05	0.02	0.05	0.05	0.10	0.03	0.10	0.10	0.10
1334	0.10	0.10	0.20	0.20	0.20	0.20	0.10	0.28	0.20
1413	0.20	0.17	0.20	0.20	0.10	0.20	0.20	0.10	0.20
1496	0.10	0.15	0.20	0.20	0.10	0.20	0.20	0.20	0.30
1585	0.18	0.20	0.20	0.23	0.17	0.22	0.22	0.28	0.38
1679	0.20	0.15	0.15	0.15	0.20	0.20	0.20	0.20	0.30
1778	0.30	0.20	0.20	0.30	0.32	0.30	0.30	0.30	0.30
1884	0.30	0.22	0.30	0.30	0.40	0.30	0.30	0.30	0.30
1995	0.30	0.30	0.30	0.40	0.40	0.40	0.40	0.38	0.30
2113	0.33	0.33	0.40	0.40	0.40	0.40	0.50	0.50	0.40
2239	0.30	0.30	0.30	0.40	0.40	0.50	0.40	0.50	0.40
2371	0.47	0.40	0.40	0.40	0.57	0.50	0.50	0.50	0.70
2512	0.43	0.50	0.45	0.50	0.55	0.60	0.55	0.50	0.60
2661	0.47	0.48	0.47	0.55	0.55	0.60	0.50	0.60	0.60

TABLE B.4 Directional Response (from 100° to 180°) of 3 ½-inch Windscreen (Continued)

Frequency (Hz)	Angle from Reference Direction (Degrees) ¹								
	100°	110°	120°	130°	140°	150°	160°	170°	180°
2818	0.43	0.50	0.48	0.50	0.58	0.55	0.60	0.58	0.55
2985	0.48	0.47	0.48	0.50	0.50	0.50	0.60	0.52	0.60
3162	0.40	0.40	0.40	0.40	0.50	0.50	0.50	0.50	0.50
3350	0.30	0.30	0.38	0.32	0.40	0.45	0.45	0.42	0.50
3548	0.15	0.12	0.30	0.28	0.25	0.30	0.20	0.30	0.40
3758	0.10	0.02	0.18	0.13	0.20	0.30	0.15	0.30	0.30
3981	-0.05	-0.10	-0.05	0.00	0.00	0.10	0.10	0.05	0.10
4217	-0.20	-0.23	-0.20	-0.15	-0.12	-0.07	-0.10	-0.20	-0.10
4467	-0.30	-0.35	-0.37	-0.28	-0.27	-0.20	-0.30	-0.27	-0.25
4732	-0.50	-0.60	-0.60	-0.50	-0.50	-0.50	-0.40	-0.40	-0.30
5012	-0.60	-0.70	-0.65	-0.50	-0.53	-0.50	-0.50	-0.55	-0.42
5309	-0.58	-0.60	-0.65	-0.57	-0.57	-0.53	-0.40	-0.53	-0.35
5623	-0.50	-0.58	-0.70	-0.60	-0.53	-0.50	-0.45	-0.50	-0.30
5957	-0.50	-0.52	-0.70	-0.60	-0.55	-0.50	-0.30	-0.45	-0.27
6310	-0.53	-0.40	-0.50	-0.50	-0.43	-0.50	-0.30	-0.40	-0.25
6683	-0.45	-0.30	-0.42	-0.48	-0.30	-0.40	-0.20	-0.30	-0.20
7079	-0.30	-0.20	-0.35	-0.37	-0.30	-0.30	-0.13	-0.30	-0.03
7499	-0.40	-0.33	-0.40	-0.50	-0.50	-0.40	-0.32	-0.40	-0.20
7943	-0.63	-0.62	-0.70	-0.85	-0.68	-0.70	-0.58	-0.70	-0.55
8414	-0.60	-0.70	-0.50	-0.92	-0.85	-0.88	-0.70	-0.87	-0.62
8913	-0.80	-0.90	-0.70	-1.10	-1.00	-0.90	-0.68	-0.90	-0.70
9441	-0.72	-0.95	-0.73	-1.00	-1.00	-0.80	-0.65	-0.80	-0.53
10000	-0.75	-0.90	-0.80	-1.08	-0.95	-0.75	-0.70	-0.75	-0.50
10593	-0.75	-1.03	-0.83	-1.15	-1.00	-0.88	-0.80	-0.82	-0.57
11220	-0.75	-1.20	-1.00	-1.20	-1.30	-1.22	-1.10	-1.10	-0.88
11885	-1.28	-1.18	-1.45	-1.45	-1.70	-1.60	-1.50	-1.42	-1.20
12589	-1.73	-1.40	-1.80	-1.85	-2.10	-1.83	-1.72	-1.72	-1.45
13335	-1.63	-1.18	-1.80	-1.35	-1.85	-1.43	-1.40	-1.27	-1.02

TABLE B.4 Directional Response (from 100° to 180°) of 3 ½-inch Windscreen (Continued)

Frequency (Hz)	Angle from Reference Direction (Degrees) ¹								
	100°	110°	120°	130°	140°	150°	160°	170°	180°
14125	-1.20	-1.00	-1.90	-1.03	-2.00	-1.20	-1.22	-1.10	-1.02
14962	-1.17	-1.55	-1.90	-1.55	-2.47	-1.70	-1.78	-1.63	-1.60
15849	-1.85	-2.40	-2.45	-2.15	-2.83	-2.48	-2.45	-2.22	-2.20
16788	-1.90	-2.48	-1.85	-1.75	-2.08	-2.05	-1.93	-1.55	-1.47
17783	-2.05	-1.75	-0.65	-1.53	-2.20	-1.77	-1.50	-1.12	-1.20
18836	-2.32	-1.50	-1.45	-2.58	-3.20	-2.78	-2.55	-2.40	-2.35
19953	-1.81	-2.78	-3.45	-2.88	-4.51	-2.97	-3.39	-2.95	-2.17

1. Note: These values represent the typical effect of the WS001 windscreen on the acoustic response of the 821/721 sound level meter. They may be subtracted from a measured value to correct for the windscreen effect..

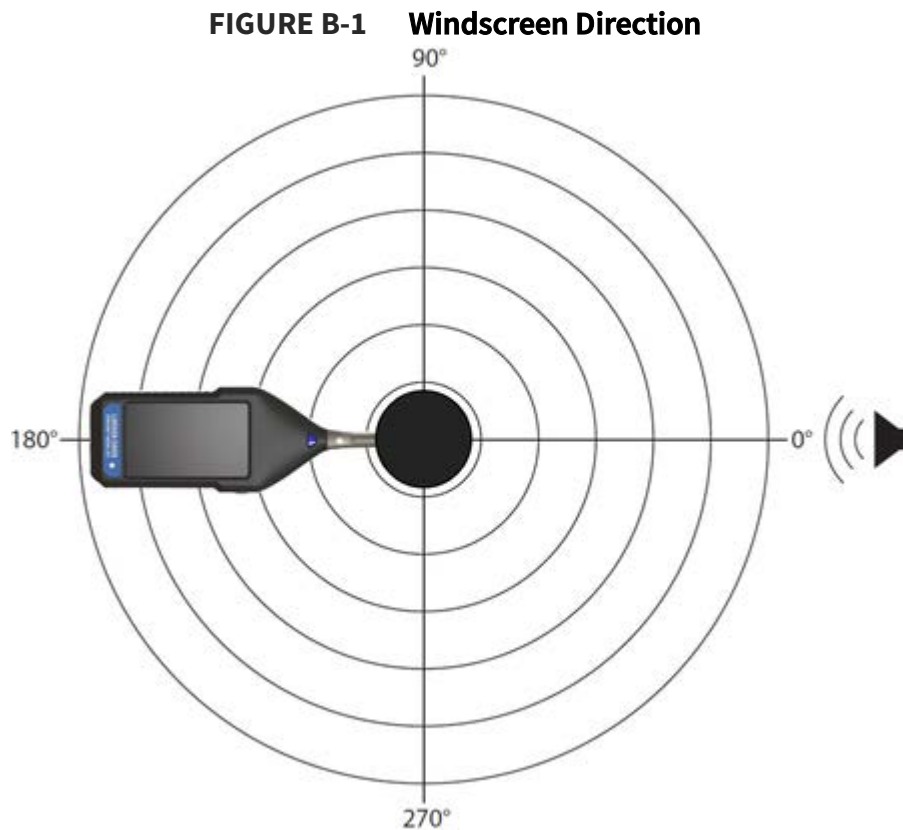

EPS2116 Environmental Protection Shroud Corrections

The following table and graph display correction factors for effects of the EPS2116 on the response of the sound level meter with either the PRM821 or PRM721 preamplifier and the 377B02 microphone. These corrections are intended for laboratory use when testing to IEC 61672-2 to account for effects of the EPS2116. The corrections are added to the electrical signals to replicate the acoustical response when the EPS2116 windscreen is in place. See **Table B.5 Test, Filter, and EPS2116 Correction Description** for the appropriate filter selection in the sound level

meter for a given test, as well as the associated correction factor to be applied. When using the appropriate microphone correction filter, the 821 meets Class 1 specifications when equipped with the EPS2116. Note that the correction factors are tabulated in **Table B.6 Effects of EPS2116 Environmental Shroud**.

Table B.5 Test, Filter, and EPS2116 Correction Description

Test	Sound Level Meter Filter	EPS 2116 Correction
Free Field Response	FF:FF 2116	Free Field to Free Field EPS2116 Correction Factor
90 Degree Response	FF:90 2116	Free Field to 90 Degree EPS2116 Correction Factor
Random Incidence Response	FF:RI 2116	Free Field to Random Incidence EPS 2116

FIGURE B-2 Graph of the EPS2116 Environmental Shroud Random Incidence Response

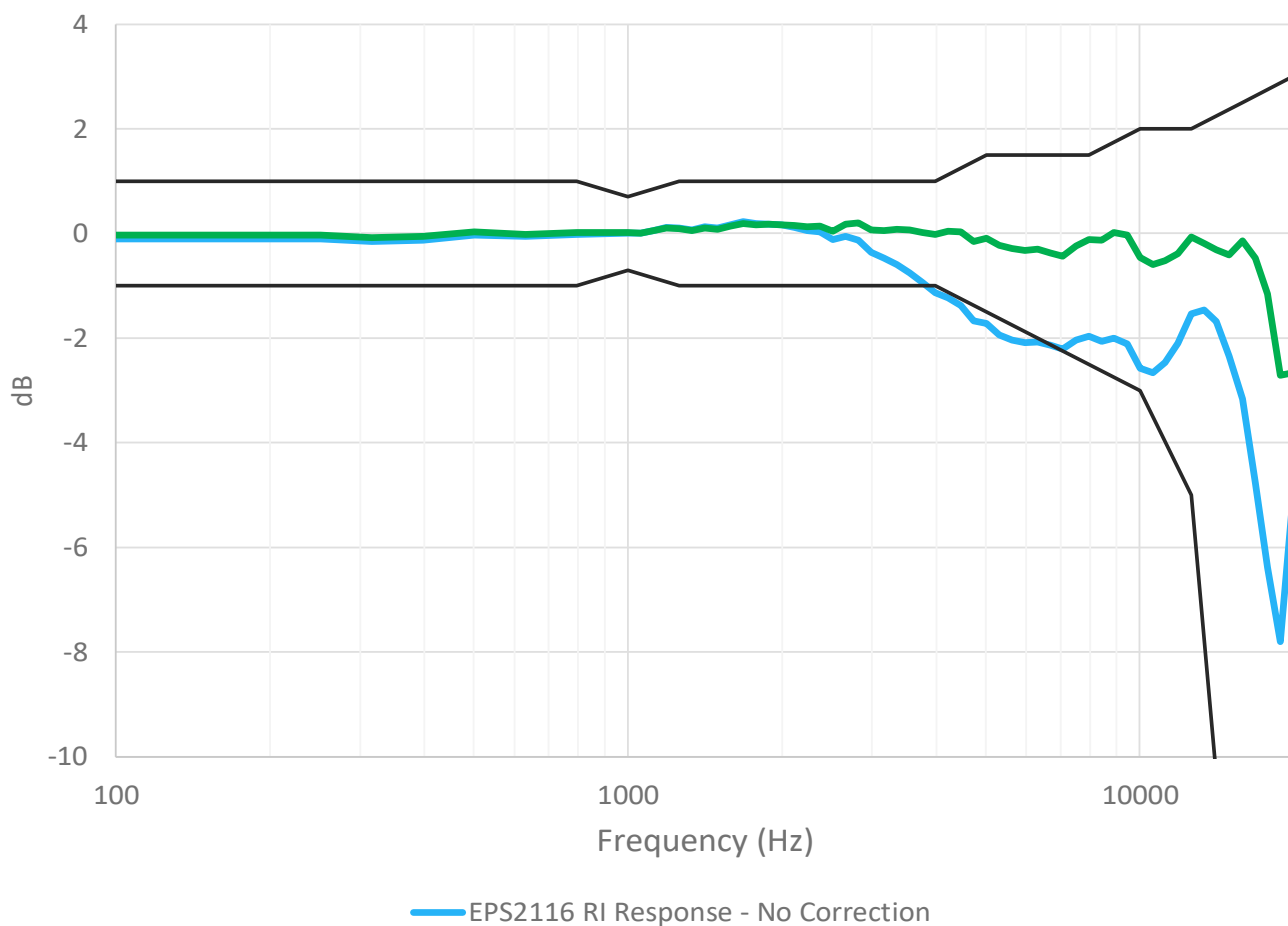
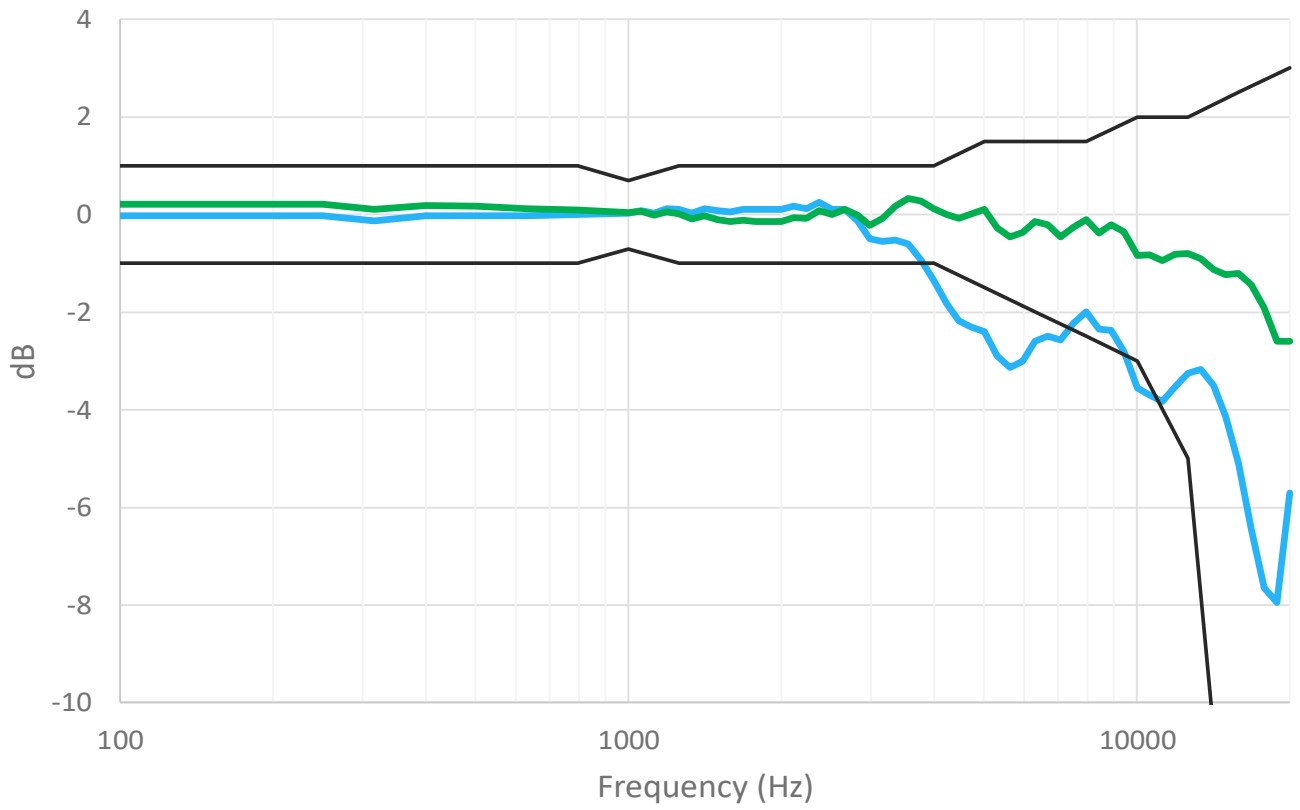
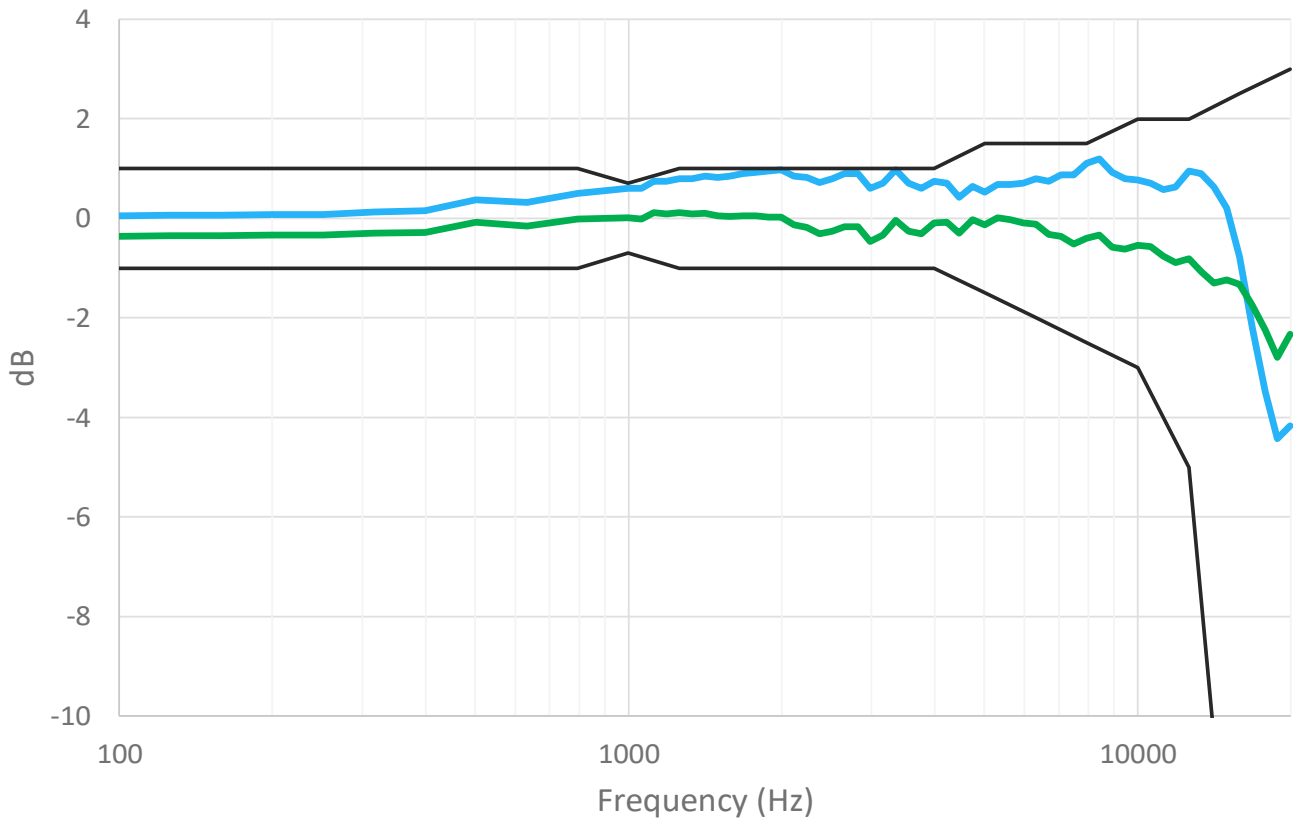

FIGURE B-3 Graph of the EPS2116 Environmental Shroud 90 Degree Response



— EPS2116 90 Degree Response - No Correction

FIGURE B-4 Graph of the EPS2116 Environmental Shroud Free-Field Response



— EPS2116 0 Degree Response - No Correction

TABLE B.6 Effects of EPS2116 Environmental Shroud

Frequency	EPS2116 at 0 Degrees	EPS2116 at 90 Degrees	EPS2116 at Random Incidence	Expanded Uncertainty of Corrections
Hz	dB	dB	dB	dB
63	0.05	-0.03	-0.10	0.20
79	0.05	-0.03	-0.10	0.20
100	0.05	-0.03	-0.10	0.20
126	0.06	-0.03	-0.10	0.20
158	0.06	-0.03	-0.10	0.20
200	0.07	-0.03	-0.10	0.20
251	0.07	-0.03	-0.10	0.20
316	0.13	-0.13	-0.16	0.20
398	0.15	-0.02	-0.13	0.20

TABLE B.6 Effects of EPS2116 Environmental Shroud (Continued)

Frequency	EPS2116 at 0 Degrees	EPS2116 at 90 Degrees	EPS2116 at Random Incidence	Expanded Uncertainty of Corrections
Hz	dB	dB	dB	dB
501	0.37	-0.03	-0.03	0.20
631	0.32	-0.02	-0.06	0.20
794	0.50	0.00	-0.01	0.20
1000	0.60	0.03	0.00	0.20
1059	0.60	0.08	0.00	0.20
1122	0.75	0.02	0.06	0.20
1189	0.75	0.12	0.11	0.20
1259	0.80	0.10	0.11	0.20
1334	0.80	0.03	0.07	0.20
1413	0.85	0.12	0.13	0.20
1496	0.82	0.08	0.10	0.20
1585	0.85	0.05	0.17	0.20
1679	0.90	0.10	0.22	0.20
1778	0.93	0.10	0.19	0.20
1884	0.95	0.10	0.18	0.20
1995	0.98	0.10	0.16	0.20
2113	0.85	0.17	0.12	0.20
2239	0.82	0.12	0.06	0.20
2371	0.73	0.25	0.03	0.20
2512	0.80	0.10	-0.12	0.20
2661	0.90	0.10	-0.06	0.20
2818	0.90	-0.13	-0.13	0.20
2985	0.60	-0.50	-0.37	0.20
3162	0.70	-0.55	-0.48	0.20
3350	0.97	-0.53	-0.60	0.20
3548	0.70	-0.60	-0.76	0.20

TABLE B.6 Effects of EPS2116 Environmental Shroud (Continued)

Frequency	EPS2116 at 0 Degrees	EPS2116 at 90 Degrees	EPS2116 at Random Incidence	Expanded Uncertainty of Corrections
Hz	dB	dB	dB	dB
3758	0.60	-0.92	-0.94	0.20
3981	0.75	-1.35	-1.13	0.20
4217	0.70	-1.82	-1.23	0.30
4467	0.43	-2.17	-1.38	0.30
4732	0.65	-2.30	-1.68	0.30
5012	0.53	-2.40	-1.73	0.30
5309	0.67	-2.90	-1.94	0.30
5623	0.67	-3.13	-2.04	0.30
5957	0.70	-3.00	-2.09	0.30
6310	0.80	-2.60	-2.07	0.30
6683	0.75	-2.50	-2.14	0.30
7079	0.88	-2.57	-2.21	0.30
7499	0.88	-2.22	-2.04	0.30
7943	1.10	-2.00	-1.97	0.30
8414	1.20	-2.35	-2.06	0.30
8913	0.93	-2.37	-2.00	0.30
9441	0.80	-2.80	-2.12	0.30
10000	0.77	-3.55	-2.57	0.30
10593	0.70	-3.70	-2.66	0.30
11220	0.58	-3.82	-2.46	0.30
11885	0.62	-3.52	-2.11	0.30
12589	0.95	-3.25	-1.54	0.30
13335	0.90	-3.17	-1.47	0.30
14125	0.63	-3.50	-1.69	0.30
14962	0.20	-4.15	-2.35	0.30
15849	-0.77	-5.10	-3.17	0.30

TABLE B.6 Effects of EPS2116 Environmental Shroud (Continued)

Frequency	EPS2116 at 0 Degrees	EPS2116 at 90 Degrees	EPS2116 at Random Incidence	Expanded Uncertainty of Corrections
Hz	dB	dB	dB	dB
16788	-2.20	-6.45	-4.77	0.30
17783	-3.47	-7.65	-6.38	0.30
18836	-4.42	-7.95	-7.80	0.30
19953	-4.17	-5.70	-5.00	0.30

Note: These corrections can be added to electrical test measurement data to simulate the windscreen effect.

The following sections f) through o) are applicable for the PRM821 preamplifier.

f) Linear Operating Range

TABLE B.7 Linearity Range (Nominal Values)

Weighting	31.5 Hz		1 kHz		4 kHz		8 kHz		12.5 kHz	
	Lower	Upper	Lower	Upper	Lower	Upper	Lower	Upper	Lower	Upper
A	24	100	24	140	24	141	24	138	24	133
C	28	137	27	140	27	139	27	136	27	131
Z	38	140	37	140	37	140	37	140	37	140
C Peak	50	140	50	143	50	142	50	139	50	134

g) Linear Measurement Starting Point

TABLE B.8 Linear Measurement Starting Point

	31.5 Hz	1 kHz	4 kHz	8 kHz	12.5 kHz
Level (dB)	74.5	114	115	112.9	109.7

h) Electrical Insert Signals

The electrical design of the input device to insert electrical signals into the preamplifier is a series 12pF ± 5% capacitor. The Larson Davis adapter (ADP090) is used for this purpose.

i) Self Generating Noise in Low Level Sound Field

TABLE B.9 SLM Self-Generated Noise Levels

The following self-generated noise levels represent the highest anticipated self-generated electronic noise of the instrument with an adapter ADP090 (12 pF) in place of the microphone.

Freq Weighting	Typical (dB)	Max (dB)
A	12	15
C	14	17
Z	22	25

TABLE B.10 SLM Self-generated Noise Levels

The following self-generated noise levels represent a combination of the electronic and thermal noise of the 377B02 microphone at 68 °F (20 °C) measured in a sealed, vibration-isolated cavity, with averaging time greater than 30 seconds.

Freq Weighting	Typical (dB)	Max (dB)
A	17	20
C	18	21
Z	25	28

j) Highest Sound Pressure Level

The highest sound pressure level the 821/721 is designed to accommodate at the level of overload is 140 dB. The maximum peak-to-peak voltage is 28 Vpp input through the adapter, ADP090.

k) Battery Power Voltage Range

The battery power supply voltage range for which the meter conforms to this standard: 4.35 Volts maximum. The 821/721 powers off when the battery is below 2.85 Volts. Therefore, from 2.85 to 4.35 Volts is the usable range of battery voltage. The instrument powers off outside this range to ensure no data is taken that would not meet the requirements of IEC 61672.

l) Typical Stabilization Time

The typical time interval needed to stabilize after changes in environmental conditions:

- For a temperature change of 5 °C, then 30 minutes are required.
- For a static pressure change of 5 kPa, then 15 seconds are required.
- For a humidity change of 25% (non-condensing), then 30 minutes are required.

m) Field Strength > 10 V/m

The 821/721 was not measured for field strengths greater than 10 V/m.

n) Radio Frequency Emission

The mode of operation of the 821/721 that produces the greatest radio frequency emission levels is when charging the battery wirelessly.

o) AC Power and Radio Frequency Susceptibility

The manner of operation for 821/721 that produced the least immunity to the effects of exposure to AC power-frequency and radio frequency is charging via USB in the vertical position with the screen powered on.

FIGURE B-5 Susceptibility to EM Field

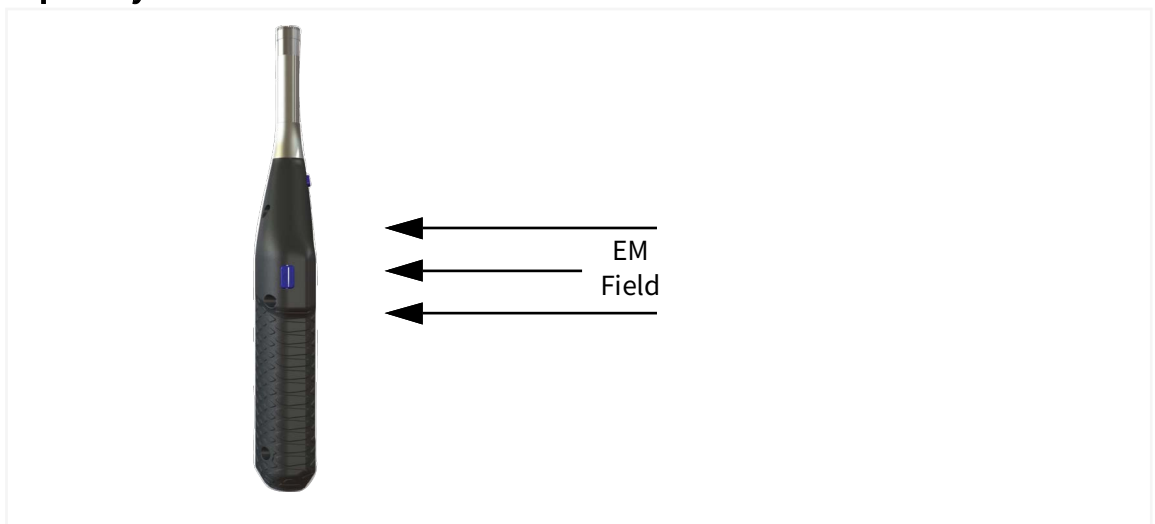

This appendix contains technical definitions of key acoustical and vibration terms commonly used with Larson Davis instruments. The reader is referred to American National Standards Institute document S1.1-1994 (R2004) for additional definitions. Specific use of the terms defined are in the main body of this manual.

Allowed Exposure Time (T_i)

The allowed time of exposure to sound that a constant A-weighted sound level in a chosen Criterion Level, Criterion Duration, and Exchange Rate.

The equation for T_i is

$$T_i = \frac{T_c}{2^{(L_{avg} - L_c)/Q}} = \frac{T_c}{10^{(L_{avg} - L_c)/q}}$$

where L_c is the Criterion Level, T_c is the Criterion Duration, Q is the Exchange Rate, q is the Exchange Rate Factor and L_{AVG} is the Average Sound Level.

Example: If $L_c = 90$, $T_c = 8$, $Q = 3$ and $L_{AVG} = 95$ then

$$T_i = \frac{8}{2^{(95 - 90)/3}} = \frac{8}{10^{(95 - 90)/10}} = 2.52 = 2 \text{ hours and } 31 \text{ minutes}$$

This means that if a person is in this area for 2 hours and 31 minutes he will have accumulated a Noise Dose of 100%. Standard: ANSI S12.19.

See **Exchange Rate (Q), Exchange Rate Factor (q), Exposure Factor (k)**

Average Sound Level (L_{avg})

The level of a constant sound, expressed in dB, which in a given time period ($T = T_2 - T_1$) would expose a person to the same noise dose as the actual (unsteady) sound over the same period. ANSI S1.25-1991 defines L_{AVG} or average sound level.

$$L_{avg} = q \times \log_{10} \left(\frac{1}{T} \int_{T_1}^{T_2} 10^{\frac{L_{AS}}{q}} dt \right) \text{ dB}$$

L_{AS} = A-weighting frequency and slow-exponential weighting time sound level in dB (in the formula above, if the sound level is less than the user-specified threshold level, then $L_{AS} = -\infty$)
 T = measurement period or Run Time ($T = T_2 - T_1$)

q = exchange rate constant

- if exchange rate = 3, $q = 10$
- If exchange rate = 4, $q = 4 / \log_{10}(2) \approx 13.29$
- If exchange rate = 5, $q = 5 / \log_{10}(2) \approx 16.61$
- If exchange rate = 6, $q = 20$

C Minus A, C-A

This measurement is an average level (L_{avg}) of frequency-weighted values. It's application to the measured sound signal enhances the low-frequency components. It's the result of subtracting the A-weighted average level (L_{avg}) from the C-weighted average level (L_{avg}) for the same measured signal.

Community Noise Equivalent Level (CNEL, L_{DEN})

L_{DEN} , a rating of community noise exposure to all sources of sound that differentiates between daytime, evening and nighttime noise exposure. The equation for L_{DEN} is:

$$L_{DEN} = 10 \log_{10} \left\{ \frac{1}{24} \left[\sum_{0000}^{0700} 10^{(L_i + 10)/10} + \sum_{0700}^{1900} 10^{L_i/10} + \sum_{1900}^{2200} 10^{(L_i + 5)/10} + \sum_{2200}^{2400} 10^{(L_i + 10)/10} \right] \right\}$$

The continuous equivalent sound level is generally calculated on an hourly basis and is shown in the equation as L . The levels for the hourly periods from midnight to 7 a.m. have a penalty of 10 dB added to them to represent less tolerance for noise during sleeping hours. The same occurs from 10 p.m. to midnight. The levels for the hourly periods between 7 p.m. and 10 p.m. have a penalty of 5 dB added to them to represent a lessened tolerance for noise during evening activities. They are energy summed and converted to an average noise exposure rating.

Criterion Duration (T_c)

It is the time required for a constant sound level equal to the Criterion Level to produce a Noise Dose of 100%. Criterion Duration is typically 8 hours.

Example: If the Criterion Level = 90 dB and the Criterion Duration is 8 hours, then a sound level of 90 dB for 8 hours, will produce a 100% Noise Dose. See Noise Dose. Standard: ANSI S12.19

Criterion Sound Exposure (CSE)

The product of the Criterion Duration and the mean square sound pressure associated with the Criterion Sound Level when adjusted for the Exchange Rate. It is expressed in Pascals-squared seconds when the exchange rate is 3 dB, where q is the Exchange Rate Factor. See **Exchange Rate (Q), Exchange Rate Factor (q), Exposure Factor (k)**.

$$CSE = T_c \times 10^{\frac{L_c}{q}}$$

Standard: ANSI S1.25

Criterion Sound Level (L_c)

It is the sound level which if continually applied for the Criterion Duration will produce a Noise Dose of 100%. The current OSHA Criterion Level is 90 dB.

Standard: ANSI S12.19

Daily Personal Noise Exposure ($L_{EP,d}$)

It is the level of a constant sound over the Criterion Duration that contains the same sound energy as the actual, unsteady sound over a specific period. The period is generally shorter, so the sound energy is spread out over the Criterion Duration period.

Example: If the Criterion Duration = 8 hours and the specific period is 4 hours and the average level during the 4 hours is 86 dB, then the $L_{EP,d} = 83$ dB.

Day-Night Average Sound Level (DNL, L_{DN})

A rating of community noise exposure to all sources of sound that differentiates between daytime and nighttime noise exposure. The equation for it is

$$L_{DN} = 10 \log_{10} \left\{ \frac{1}{24} \left[\sum_{0000}^{0700} 10^{(L_i + 10)/10} + \sum_{0700}^{2200} 10^{L_i/10} + \sum_{2200}^{2400} 10^{(L_i + 10)/10} \right] \right\}$$

The continuous equivalent sound level (See definition) is generally calculated on an hourly basis and is shown in the equation as L.

The values for the hourly periods from midnight to 7 a.m. have 10 added to them to represent less tolerance for noise during sleeping hours. The same occurs from 10 p.m. to midnight. They are energy summed and converted to an average noise exposure rating.

Decibel (dB)

A unit of measure commonly used to describe the ratio of one power level or field level value to another on a logarithmic scale. The decibel is a simplified way of representing a large span of signal levels, and sometimes very large numbers, as opposed to using the Pascal. For example:

dB	Power Ratio	Amplitude Ratio
50	100 000	316.2
3	3.995 \approx 4	1.995 \approx 2
-50	0.000 01	0.003 162

To directly add or subtract physical quantities expressed in decibel form, you can use the following equation to convert decibels to Pascals.

$$dB = 10 \log_{10} \left[\frac{P^2}{P_0^2} \right] = 20 \log_{10} \left[\frac{P}{P_0} \right]; p_0 = 20 \mu Pa$$

With regard to measuring noise exposure, remember the following rules when dB values are used for sound levels:

- Doubling of the Sound Pressure = 6 dB

- Doubling of the Sound Power = 3 dB
- Doubling of the Perceived Sound Level = (approx.) 10 dB

Detector

The detector converts the actual fluctuating sound from the microphone into a signal that indicates its amplitude. Your choice for the Detector setting (Slow, Fast, or Impulse) determines the amplitude change rate. The detector first squares the sound signal, then averages it in accordance with the time-weighting characteristic, and then takes the square root. This results in an amplitude described as rms (root-mean-square).

The Slow and Fast detector responses were originally developed to slow down the movement of the needle on an electro-mechanical meter, so that the amplitude could be determined. Slow and Fast detector settings are still useful in modern sound measurement instruments. Slow has a time constant of 1 second. Fast has a time constant of 1/8th second. The Impulse setting is a non-linear detector with the rise controlled by a 35 ms time constant followed by a peak hold that has a decay rate of 2.9 dB/second.

Dose

See **Noise Dose (Dose)**.

Eight-Hour Time-Weighted Average Sound Level (L_{TWA(8)})

It is the constant sound level that would expose a person to the same Noise Dose as the actual (unsteady) sound levels. The equation for this, according to the ANSI S12.19 standard, is shown below:

$$L_{TWA(8)} = L_c + q \times \text{Log}_{10}\left(\frac{D}{100}\right)$$

NOTE: This definition applies only for a Criterion Duration of 8 hours.

Equivalent Continuous Sound Level (L_{eq})

L_{eq} is the level of a constant sound over a specific time period that has the same sound energy as the actual (unsteady) sound over the same period. It is one way to describe sound levels that vary over time as a single decibel value, which takes into account the total sound energy for the period of interest. While not technically correct, it's often referred to as the "average" noise level for a measurement.

For sound level meters, an L_{eq} value is recorded for two separate intervals. The first interval records the value of L_{eq} for the entire record's run time. The second records the value of L_{eq} for each individual time history sample. Therefore, the time period of interest has the same total sound energy as does a sample with varying sound ($T = T_2 - T_1$). The L_{eq} is annotated as L_{Aeq} for an A-weighted L_{eq} , or as L_{Ceq} for a C-weighted L_{eq} .

$$L_{eq} = 10 \times \log_{10} \left(\frac{1}{T} \times \int_{T_1}^{T_2} \frac{p^2(t)}{p_0^2} dt \right) \text{ dB}$$

$p(t)$ = instantaneous, frequency-weighted (A or C), sound pressure in pascals

p_0 = reference sound pressure, 20 μ Pa

T = measurement period or Run Time ($T = T_2 - T_1$)

Note: The default exchange rate for L_{eq} is 3 dB for ISO and British Standard measurements. In some countries, other rules may apply. OSHA (U.S.A.) standards use 5 dB as the default exchange rate. These values and others are shown as default values in the 721/821 Dosimeter Settings.

Equivalent Time-Weighted Average TWA(x)

The level of a constant sound expressed in dB, which, if measured for a time period equal to the Criterion Duration, produces the currently measured noise dose.

$$TWA(x) = L_{avg} + q \times \log_{10} \left[\frac{T}{T_c} \right] \text{ dB}$$

L_{avg} = average sound level in dB, only recording values higher than the user specified threshold level

T = measurement period or Run Time

T_c = Criterion Duration in hours (8 hours)

q = exchange rate constant

If exchange rate = 3, $q = 10$

If exchange rate = 4, $q = 4 / \log_{10}(2) \approx 13.29$

If exchange rate = 5, $q = 5 / \log_{10}(2) \approx 16.61$

The x in $TWA(x)$ represents the Criterion Duration. For example, suppose a worker is exposed to a noise environment with L_{AVG} of 90 dB. Also, assume that the exchange rate is 5, the criterion level is 90 dB, and the Criterion Duration is 8 hours.

After 1 hour, the worker's noise dose is 12.5%, the $TWA(8)$ is 75.0 dB, and the L_{avg} is 90.0 dB. A $TWA(8)$ of 75 dB indicates that if the worker is instead exposed to a noise environment with a L_{avg} of 75 dB, the noise dose after 8 hours is 12.5%.

Energy Equivalent Sound Level (L_{eq})

See [Equivalent Continuous Sound Level \(\$L_{eq}\$ \)](#)

Exchange Rate (Q), Exchange Rate Factor (q), Exposure Factor (k)

It is defined in ANSI S1.25 as “the change in sound level corresponding to a doubling or halving of the duration of a sound level while a constant percentage of criterion exposure is maintained.” The rate and the factors are given in the table below.

TABLE C.1 Exchange Rate

Exchange Rate, Q	Exchange Rate Factor, q	Exposure Factor, k
3.01	10	1
4	13.29	.75
5	16.61	.60
6.02	20	.50

Standard: ANSI S12.19

Far Field

There are two types of far fields: the acoustic far field and the geometric far field.

Acoustic Far Field: The distance from a source of sound is greater than an acoustic wavelength. In the far field, the effect of the type of sound source is negligible. Since the wavelength varies with frequency (See the definition of Wavelength), the distance will vary with frequency. To be in the far field for all frequencies measured, the lowest frequency should be chosen for determining the distance. For example, if the lowest frequency is 20 Hz, the wavelength at normal temperatures is near 56 ft. (17 m); at 1000 Hz, the wavelength is near 1.1 ft. (1/3 m). To learn more about the advantages of being in the acoustic far field, see [Acoustic Near Field](#):

Geometric Far Field: The distance from a source of sound is greater than the largest dimension of the sound source. In the far field, the effect of source geometry is negligible. Sound sources often have a variety of specific sources within them, such as exhaust and intake noise. When in the far field, the sources have all merged into one, so that measurements made even further away will be no different. To learn more about the advantages of being in the geometric far field, see [Geometric Near Field](#):

Free Field

A sound field that is free of reflections. This does not necessarily mean that the sound is all coming from one direction, as is often assumed. The source of sound may be spatially extensive. See the definitions of near and far fields for more detail. This definition is often used in conjunction with reverberant field.

Frequency (Hz, rad/sec)

The rate at which an oscillating signal accomplishes a complete cycle by returning to the original value. It can be expressed in cycles per second, which uses the unit symbol “Hz” (Hertz), or in radians per second, which has no unit symbol. The Greek letter “ ω ” and the letter “f” are used for universal descriptors. The two expressions are related through the equation $\omega=2\pi f$.

Frequency Band Pass Filter

The part of certain sound level meters that divides the frequency spectrum on the sound or vibration into a part that is unchanged and a part that is filtered out. It can be composed of one or more of the following types:

Low Pass: A frequency filter that permits signals to pass through that have frequencies below a certain fixed frequency, called a cutoff frequency. It is used to discriminate against higher frequencies.

High Pass: A frequency filter that permits signals to pass through that have frequencies above a certain fixed frequency, called a cutoff frequency. It is used to discriminate against lower frequencies.

Bandpass: A frequency filter that permits signals to pass through that have frequencies above a certain fixed frequency, called a lower cutoff frequency, and below a certain fixed frequency, called an upper cutoff frequency. The difference between the two cutoff frequencies is called the bandwidth. It is used to discriminate against both lower and higher frequencies so it passes only a band of frequencies.

Octave band: A bandpass frequency filter that permits signals to pass through that have a bandwidth based on octaves. An octave is a doubling of frequency so the upper cutoff frequency is twice the lower cutoff frequency. This filter is often further subdivided in 1/3 and 1/12 octaves (3 and 12 bands per octave) for finer frequency resolution. Instruments with these filters have a sufficient number of them to cover the usual range of frequencies encountered in sound and vibration measurements. The frequency chosen to describe the band is the center frequency.

Frequency and Exponential Time-Weighted Sound Level ($L_{\omega\tau}$)

$L_{\omega\tau}$ corresponds to the frequency and exponential-time weighted sound level in dB. It is sometimes referred to as the “RMS sound level”. Similarly the A, C, or Z-frequency weighting is sometimes referred to as the “RMS frequency weighting,” where RMS is an acronym for root-mean-square.

$$L_{\omega\tau} = 10 \times \log_{10} \left(\frac{1}{\tau} \times \int_{-\infty}^t \frac{p^2(\xi) \times e^{-\frac{(t-\xi)}{\tau}}}{p_o^2} d\xi \right) \text{ dB}$$

$p(\xi)$ = instantaneous, frequency-weighted (A or C), sound pressure in pascals.

p_o = reference sound pressure, 20 μ Pa

t = time of observation

τ = Exponential time constant in seconds for either the S(slow)
or F(fast) time weighting

ω = Frequency weighting (A, C, or Z)

The Detector rate setting on the dosimeter corresponds to an exponential time constant of SLOW (1 second), which is designated as ω in the equation. These time constants are required by both ANSI and IEC standards.

In the $L_{\omega\tau}$ equation, ω designates the frequency weighting (A or C). For example, on the dosimeter, L_{AS} signifies the A weighted, SLOW exponential-time weighted sound level.

Frequency Weightings

Frequency weightings are commonly-used frequency filters that adjust the amplitude of all parts of the frequency spectrum of the sound of vibration.

- A-Weighting: A weighting filter that most closely matches how humans perceive sound, especially low to moderate levels. This weighting is most often used for evaluation of environmental sounds. Notated by the “A” in measurement parameters, including L_{dBA} , L_{Aeq} , L_{AF} , L_{AS} , etc.
- C-Weighting: Commonly-used filter that adjusts the levels of a frequency spectrum in the same way the human ear does when exposed to high or impulse levels of sound. This weighting is most often used for evaluating equipment noise.
- Flat or Linear Weighting: No longer used in current standards. Flat weighting indicates that no filter was applied across a stated frequency range. Since 2003, the IEC 61672 standard notes the use of Z-weighting, instead.
- Z-Weighting: “Zero” or no frequency weighting applied. In actuality, a passband filter from 10 Hz to 20 kHz. noted by the “Z” in measurement metrics, including L_{dBZ} , L_{Zeq} , L_{ZF} , L_{ZS} , etc.

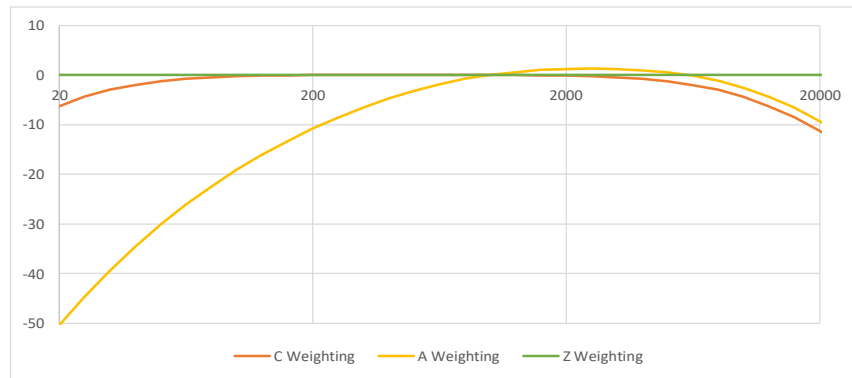

$L_{EP, d}$

The acronym used on the meter interface for the level of daily personal noise exposure. For more information, see the entry for [Daily Personal Noise Exposure \(\$L_{EP,d}\$ \)](#).

L_{eq}

See [Equivalent Continuous Sound Level \(\$L_{eq}\$ \)](#), [Sound](#), and [Time Weighting](#)

Level (dB)

A descriptor of a measured physical quantity, typically used in sound and vibration measurements. It is attached to the name of the physical quantity to denote that it is a logarithmic measure of the quantity and not the quantity itself. The word decibel is often added after the number to express the same thing. When frequency weighting is used the annotation is often expressed as dB(A) or dB(C).

L_{max}

The maximum value, expressed in dB, of the Frequency and Exponential-Time Weighted Sound Level ($L_{\omega T}$) in a given time interval. For the dosimeters, an L_{max} value is recorded for 2 different time intervals. The first records L_{max} for the entire record's time. The second records L_{max} for each individual time history sample.

L_{min}

The minimum value, expressed in dB, of the Frequency and Exponential-Time Weighted Sound Level ($L_{\omega T}$) in a given time interval. For the dosimeters, an L_{\max} value is recorded for 2 different time intervals. The first records L_{\max} for the entire record's time. The second records L_{\max} for each individual time history sample.

Ln Value

The **Ln** value is the sound level that has exceeded n% over the total measurement time. For example, if n=90%, a displayed value of 35dB for L90 means that for 90% of the measurement period the dB level was at or above 35dB. These statistical values are commonly used to describe the characteristics of non-steady sound such as environmental noise.

To calculate Ln values, the 721 or 821 creates an amplitude distribution table over the range zero to 200 dB in amplitude increments of 0.1 dB. This data permits the calculation of Ln values for any value of n in the range 00.01 to 99.99%.

Ln Values can be defined on the 721 or 821 by selecting **Tools**  → **Settings** → **Ln Settings**.

Measurement Duration (T or t)

The time period of measurement. It applies to hearing damage risk and is generally expressed in hours. Standard: ANSI S12.19

Microphone Guidelines

Microphone - Types: A device for detecting the presence of sound. Most often it converts the changing pressure associated with sound into an electrical voltage that duplicates the changes. It can be composed of one of the following types:

Capacitor (Condenser): A microphone that uses the motion of a thin diaphragm caused by the sound to change the capacitance of an electrical circuit and thereby to create a signal. For high sensitivity, this device has a voltage applied across the diaphragm from an internal source.

Electret: A microphone that uses the motion of a thin diaphragm caused by the sound to change the capacitance of an electrical circuit and thereby to create a signal. The voltage across the diaphragm is caused by the charge embedded in the electret material so no internal source is needed.

Microphone - Uses: The frequency response of microphones can be adjusted to be used in specific applications. Among those used are:

Frontal incidence (Free Field): The microphone has been adjusted to have an essentially flat frequency response when in a space relatively free of reflections and when pointed at the source of the sound.

Random incidence: The microphone has been adjusted to have an essentially flat frequency response for sound waves impinging on the microphone from all directions.

Pressure: The microphone has not been adjusted to have an essentially flat frequency response for sound waves impinging on the microphone from all directions.

What a microphone measures: A microphone detects more than just sound. The motion of a microphone diaphragm is in response to a force acting on it. The force can be caused by a number of sources only one of which are we interested: sound. Non-sound forces are: (1) direct physical contact such as that with a finger or a raindrop; (2) those caused by the movement of air over the diaphragm such as environmental wind or blowing; (3) those caused by vibration of the microphone housing; and (4) those caused by strong electrostatic fields.

Rules to prevent interference:

1. Do not permit any solid or liquid to touch the microphone diaphragm. Keep a protective grid over the diaphragm.
2. Do not blow on a microphone and use a wind screen over the microphone to reduce the effect of wind noise.
3. Mount microphones so their body is not subject to vibration, particularly in direction at right angles to the plane of the diaphragm.
4. Keep microphones away from strong electrical fields.

A microphone measures forces not pressures. We would like the microphone to measure sound pressure (force per unit area) instead of sound force. If the pressure is applied uniformly over the microphone diaphragm a simple constant (the diaphragm area) relates the two, but if the pressure varies across the diaphragm the relationship is more complex. For example, if a negative pressure is applied on one-half the diaphragm and an equal positive pressure is applied to the other half, the net force is zero and essentially no motion of the diaphragm occurs. This occurs at high frequencies and for specific orientations of the microphone.

Rules to obtain the most accurate measurement:

1. Do not use a microphone at frequencies higher than specified by the manufacturer; to increase the frequency response choose smaller microphones.
2. Choose a microphone for free field or random incidence to minimize the influence of orientation.

A microphone influences the sound being measured. The microphone measures very small forces, low level sound can run about one-billionth of a PSI! Every measurement instrument changes the thing being measured, and for very small forces that effect can be significant. When sound impinges directly on a microphone the incident wave must be reflected since it cannot pass through the microphone. This results in the extra force required to reflect the sound and a microphone output that is higher than would exist if the microphone were not there. This is more important at high frequencies and when the microphone is facing the sound source.

Rules:

1. Do not use a microphone at frequencies higher than specified by the manufacturer; to increase the frequency response choose smaller microphones.
2. Choose a microphone for free field or random incidence to minimize the influence of orientation.

A microphone measures what is there from any direction: Most measurements are intended to measure the sound level of a specific source, but most microphones are not directional so they measure whatever is there, regardless of source.

Rules:

1. When making hand-held measurements, keep your body at right angles to the direction of the sound you are interested in and hold the meter as far from your body as possible. Use a tripod whenever possible.
2. Measure the influence of other sources by measuring the background sound level without the source of interest. You may have to correct for the background.

Near Field

There are two types of near fields: the acoustic near field and the geometric near field.

Acoustic Near Field:

The distance from a source of sound is less than an acoustic wavelength. In the near field, the effect of the type of sound source is significant. Since the wavelength varies with frequency (See the definition of Wavelength), the distance will vary with frequency. The most common example of a near field is driving an automobile with an open window. As you move your ear to the plane of the window, the sound pressure level builds up rapidly (wind noise) since most of the pressure changes are to move the air and very little of it compresses the air to create sound. Persons not far way, can hardly hear what you hear. The acoustic near field is characterized by pressures that do not create sound that can be measured in the far field. Therefore measurements made here are not useful in predicting the sound levels far away or the sound power of the source.

Geometric Near Field:

The distance from a source of sound is less than the largest dimension of the sound source. In the near field, effect of source geometry is significant. Sound sources often have a variety of specific sources within them, such as exhaust and intake noise. When in the near field, the sound of a weaker, but close, source can be louder than that of a more distant, but stronger, source. Therefore measurements made here can be used to separate the various sources of sound, but are not useful in predicting the sound levels and sound spectrum far from the source.

Noise

Typically it is unwanted sound. This word adds the response of humans to the physical phenomenon of sound. The descriptor should be used only when negative effects on people are known to occur. The word is used also to describe sounds with no tonal content (random).

Noise Dose (Dose)

Noise Dose, or “Dose”, is the percentage of time a person is exposed to noise that is potentially damaging to hearing. Zero represents no exposure, and 100 or more represents complete exposure.

The allowed time of exposure is determined by the Criterion Duration and by the sound level (the higher the level, the shorter the allowed time). The sound levels must be measured with A-frequency weighting and “Slow” Time Weighting.

$$\text{Dose} = \frac{100}{T_C} \times \int_{T_1}^{T_2} 10^{\frac{L_{AS} - L_C}{q}} dt \%$$

OR

$$\text{Dose} = 100 \times \frac{T}{T_C} \times 10^{\frac{L_{\text{avg}} - L_C}{q}} \%$$

L_{AS} = A-weighting frequency and slow-exponential time weighting sound level in dB. If the sound level is less than the user specified threshold level, then $L_{AS} = -\infty$

L_{avg} = average sound level in dB, only records values higher than the user specified threshold level

L_C = Criterion Level in dB

T = measurement period or Run Time ($T = T_2 - T_1$)

T_C = Criterion Duration in hours (8 hours)

q = exchange rate constant

- If exchange rate = 3, q = 10
- If exchange rate = 4, q = $4 / \log_{10}(2) \approx 13.29$
- If exchange rate = 5, q = $5 / \log_{10}(2) \approx 16.61$
- If exchange rate = 6, q = 20

Noise Exposure

See [Sound Exposure \(E\)](#)

Peak

The maximum value of the instantaneous, frequency weighted (A, C, or Z), sound pressure in a given time interval. For the dosimeter, a Peak value is recorded for 2 different time intervals. The first records the Peak for an entire record's run time (Peak Overall). The second records the Peak for each individual time history sample.

The peak level displays on the meter as $L_{\langle \text{frequency weight} \rangle \text{peak}}$; $L_{A\text{peak}}$ is an example.

Peak Frequency Weighting

The frequency weighting of the peak detector. Possible selections are A, C, Z. Peak weighting is independent of the RMS frequency weighting. For additional information, see the entry for [Frequency Weightings](#).

Preamplifier

A preamplifier is a part of a sound level meter that matches a particular model of microphone to the meter. It must be chosen in conjunction with a microphone and a cable that connects them.

Projected Daily Personal Noise Exposure

(P.LEP,d or P.LEX,8h) The Daily Personal Noise Exposure assuming that the current rate of noise dose exposure continues for the duration of a work shift (Shift Time). For example, a measured L_{eq} of 86 dB with a Run Time of 4 hours will produce a $L_{EP,d}$ or $L_{EX,8h}$ of 83 dB, but a projected P.LEP,d or P.LEX,8h of 86 dB if the Shift Time is 8 hours. If the shift time is doubled (16 hours), the P.LEP,d or P.LEX,8h would become 89 dB.

$$P.LEP,d \text{ or } P.LEX,8h = L_{eq} + 10 \times \log_{10} \left[\frac{T_S}{T_n} \right] \text{ dB}$$

L_{eq} = frequency weighted (A or C), equivalent-continuous sound pressure level in dB

T_n = normalization period or Criterion Duration (8 hours)

T_S = work shift duration, Shift Time

Projected Noise Dose

Projected Noise Dose is the Noise Dose assuming that the current rate of noise exposure continues for the full duration of an 8 hour work shift. Displays on the dosimeter LCD as P. Dose.

$$P.Dose = \left(\frac{T_S}{T} \right) \times \left(\frac{100}{T_C} \right) \times \int_{T_1}^{T_2} 10^{\frac{L_{AS} - L_C}{q}} dt \%$$

OR

$$P.Dose = 100 \times \frac{T_S}{T_C} \times 10^{\frac{L_{avg} - L_C}{q}} \%$$

OR

$$P.Dose = Dose \times \left[\frac{T}{T_C} \right] \%$$

L_{AS} = A-weighting frequency and slow-exponential weighting time sound level in dB (in the formula above, if the sound level is less than the user specified threshold level, then $L_{AS} = -\infty$)

L_{avg} = average sound level in dB, only recording values higher than the user specified threshold level

L_C = Criterion Level in dB

T = measurement period or Run Time ($T = T_2 - T_1$)

T_S = work shift duration, Shift Time

T_C = Criterion Duration in hours (8 hours)

q = exchange rate constant

- if exchange rate = 3, $q = 10$

- If exchange rate = 4, $q = 4 / \log_{10}(2) \approx 13.29$

- If exchange rate = 5, $q = 5 / \log_{10}(2) \approx 16.61$

- If exchange rate = 6, $q = 20$

Projected Sound Exposure (E₈ or E₄₀)

Projected Sound Exposure shows what the actual sound exposure will be for a specific time period if the current Equivalent-Continuous Sound Level (L_{eq}) remains at its current level. The dosimeters calculate an 8-hour and a 40-hour projected sound exposure.

$$E_8 = \frac{8}{T} \times \int_{T_1}^{T_2} p^2(t) dt$$

AND

$$E_{40} = \frac{40}{T} \times \int_{T_1}^{T_2} p^2(t) dt$$

$p(t)$ = instantaneous, frequency weighted (A, C, or Z), sound pressure in pascals

$T_2 - T_1$ = measurement period or Run Time

Projected Time-Weighted Average, P.TWA(x)

The projected Time-Weighted Average is the Equivalent Time-Weighted Average assuming that the current rate of noise exposure continues for the duration of a work shift (Shift Time). This metric displays as “P. TWA” on the dosimeter screen.

$$P.TWA(x) = L_{avg} + q \times \log_{10} \left[\frac{T_S}{T_C} \right] \text{ dB}$$

L_{avg} = average sound level in dB, only recording values higher than the user specified threshold level

T_S = work shift duration or Shift Time

T_C = Criterion Duration in hours (8 hours)

q = exchange rate constant

• If exchange rate = 3, $q = 10$

• If exchange rate = 4, $q = 4 / \log_{10}(2) \approx 13.29$

• If exchange rate = 5, $q = 5 / \log_{10}(2) \approx 16.61$

• If exchange rate = 6, $q = 20$

RMS Value (Root-Mean-Square Value)

One method of describing the energy in a sampled waveform. A waveform is often described by the wave's peak value. However, the peak value occurs only once positively and once negatively within a cycle. Since the RMS value (root-mean-square) occurs twice positively and twice negatively, as identified in *Figure C-1*, the sum of these, provides a better sample of the total energy of the measured sound. For this reason, RMS is often applied in the process of calculating noise exposure. Mathematically, the RMS value is defined as the square root of the mean value of the squared values of the quantity taken over an interval (time).

FIGURE C-1

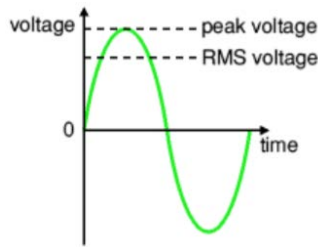

The RMS value of any function $y = f(t)$ over the range $t = a$ to $t = b$ can be defined by the following equation:

$$\sqrt{\frac{1}{b-a} \int_a^b y^2 dt}$$

Shift Time

Shift Time is the length of time in hours that a dosimeter subject could be exposed to noise at work. It's used to calculate Projected LEP, d; P. LEX, 8h; Projected Dose; and Projected TWA. In the dosimeter Settings, enter the Shift Time at the following locations: **Settings** → **Dosimeter 1, 2, or 3**.

Sound

Sound is comprised of rapid oscillatory compression changes in a solid, liquid, or gas medium that propagate to distant points. It is characterized by changes in density, pressure, motion, and temperature. Not all rapid changes in the medium are sound since they do not propagate. Wind noise is an example of this. Sound can also be characterized as the auditory sensation evoked by the oscillatory changes.

Sound is the physical phenomenon associated with acoustic (small) pressure waves. Noise is unwanted sound that causes adverse effects in those exposed to it, such as hearing loss or annoyance. It can also be defined as the sound made by other people. In every case, choosing the word *noise* involves a judgment of whether the sound is welcome or not.

Sound Exposure (E)

The total sound energy of the actual sound in a given time interval. For a dosimeter, the time interval is the record's Run Time. The units for sound exposure are Pa²S (pascal squared seconds) or Pa²H (pascal squared hours).

$$E = \int_{T_1}^{T_2} p^2(t) dt$$

$p(t)$ = instantaneous, frequency weighted (A or C), sound pressure in pascals

$T_2 - T_1$ = measurement duration or "Run Time"

Sound Exposure Level (SEL, LE)

The total sound energy in a specific time period usually expressed in decibels. The following equation shows that the sound pressure is squared and integrated over a specific period of time (t_2-t_1).

$$SEL = 10 \times \log_{10} \left[\frac{\int_{T_1}^{T_2} p^2(t) dt}{P_0^2 t} \right] \text{ dB}$$

The Sound Exposure Level is usually expressed in Pascals squared-seconds or Pascals squared-hours. P_0 is the reference pressure of 20 μPa , and “t” is the reference time of 1 second. It is then put into logarithmic form. It’s important to note that this is not an average since the reference time is not the same as the integration time.

Sound Pressure

Sound Pressure is the physical characteristic of sound that can be detected by microphones. Not all pressure signals detected by a microphone are sound (e.g., wind noise).

Sound Pressure is the amplitude of the oscillating sound pressure and is measured in Pascals (Pa), or Newtons per square meter, which is a metric equivalent of pounds per square inch. To measure sound, a sound level meter uses a detector to separate the oscillating pressure from the steady (barometric) pressure. The sound level meter then squares the pressure, takes the time average, and takes the square root (this is called rms for root-mean square). This method is one of several ways to mathematically measure sound.

Moving Average: The averaging process is continually accepting new data so it is similar to an exponential moving average. In the equation, the sound pressure is squared and multiplied by a exponential decay factor, so that when the time of integration is near the current time (t) it is essentially undiminished.

$$p_{\text{rms}} = \sqrt{\frac{1}{T} \int_{t_s}^t p^2(\xi) e^{-(t-\xi)/T} d\xi}$$

For times older (less) than the current time, the value is diminished and so becomes less important. The rate at which older data are made less influential is expressed by the constant T. The larger it is, the slower the decay factor reduces and the slower the response of the system to rapid changes. These are standardized into three values called Time Weighting. For more information on these values, see **Time Weighting**.

Fixed Average: The averaging process is over a fixed time period. The equation for it is

$$p_{\text{rms}} = \sqrt{\frac{1}{(T_2 - T_1)} \int_{T_1}^{T_2} p^2(t) dt}$$

The sound pressure is squared and averaged over a fixed time period. Unlike the moving average, the sound pressures in all time intervals are equally weighted.

Sound Pressure Level (SPL, L_p)

The logarithmic form of sound pressure. It is also expressed by attachment of the word decibel to the number. The logarithm is taken of the ratio of the actual sound pressure to a reference sound pressure which is 20 Micro-pascals (μ Pa). There are various descriptors attached to this level depending on how the actual sound pressure is processed in the meter:

Instantaneous: The time varying reading on a meter face on in a meter output due to changes in the sound pressure. The reading will depend on the time-weighting applied.

The fundamental relationship between the two is logarithmic

$$L_p = 20 \log_{10} \left[\frac{p_{rms}}{p_0} \right] \quad p_{rms} = p_0 10^{L_p/20}$$

where p_0 is the reference sound pressure of 20 μ Pa. The square of the sound pressure is a power-like quantity that can be expressed in the original form of the level definition

$$L_p = 10 \log_{10} \left[\frac{p_{rms}^2}{p_0^2} \right] \quad p_{rms}^2 = p_0^2 10^{L_p/10}$$

Sound Pressure Level can be converted to sound pressure as follows. If the sound pressure is 1 Pascal, then the sound pressure level is

$$L_p = 20 \log_{10} \left[\frac{1}{20 \cdot 10^{-6}} \right] = 20 \log_{10} [50000] = 20 [4.699] = 94.0 \text{ dB}$$

Calibrators often use a level of 94 dB so they generate a sound pressure of 1 Pascal.

If the sound pressure level = 76.3 dB, then the sound pressure is

$$Pa = 20 \cdot 10^{-6} \cdot 10^{76.3/20} = 20 \cdot 10^{3.815-6} = 20 \cdot 10^{-2.185} = 20 [0.0065] = 0.13$$

Energy Average (L_{eq}): The value of a steady sound measured over a fixed time period that has the same sound energy as the actual time varying sound over the same period. This descriptor is widely used. It is a fixed average. See **Sound Pressure**

Impulse: The value of an impulsive sound. The reading will depend on the time-weighting applied.

Unweighted Peak: The peak value of a sound with a meter that has flat frequency weighting and a peak detector.

Weighted Peak: The peak value of a sound with a meter that has a frequency weighting other than flat and a peak detector.

Sound Power (W)

The sound power emitted by a sound source. It is measured in Watts.

Sound Power Level (PWL, L_w)

The logarithmic form of sound power. It is also expressed by attachment of the word decibel to the number. The logarithm is taken of the ratio of the actual sound power to a

reference sound power, which is 1 pico-watt. Sound power level cannot be measured directly, but can only be deduced through measurements of sound intensity or sound pressure around the source. The equation for it is

$$L_w = 10 \log_{10} \left[\frac{W}{W_0} \right] \quad W = W_0 10^{L_w/10}$$

Sound Speed

The speed at which sound waves propagate. It is measured in meters per second. It should not be confused with sound or particle velocity which relates to the physical motion of the medium itself.

$$c = 20.05 \sqrt{\text{degC} + 273} \text{ m/sec}$$

$$c = 49.03 \sqrt{\text{degF} + 460} \text{ ft/sec}$$

Spectrum (Frequency Spectrum)

The amplitude of sound or vibration at various frequencies. It is given by a set of numbers that describe the amplitude at each frequency or band of frequencies. It is often prefixed with a descriptor that identifies it such as sound pressure spectrum. It is generally expressed as a spectrum level.

Threshold Sound Level (Lt)

The threshold level is applied in hearing damage risk assessment. According to the ANSI S1.25 standard, it refers to the A-weighted sound level below which the dosimeter produces little or no dose accumulation. For that reason, measured sound below this level may be disregarded. The threshold should be selected to be within the measurement range of the instrument which is between 70 dB and 140 dB for the dosimeter. The OSHA Hearing Conservation threshold is 80 dB; the OSHA Permissible Exposure Limit threshold is 90 dB.

Time Weighted Average Sound Level (TWA, LTWA(TC))

It is the level of a constant sound over the Criterion Duration, that would expose a person to the same Noise Dose as the actual (unsteady) sound over the same period. If the Exchange Rate is 3 dB then the TWA is equal to the Leq.

$$L_{TWA(TC)} = K \log_{10} \left(\frac{1}{T} \int_{T_1}^{T_2} 10^{L_p(t)/K} dt \right)$$

Where $TC = T_2 - T_1$ and K is the Exchange Rate Factor. It is used for hearing damage risk assessment.

Standard: ANSI S12.19

Time Weighting

The response speed of the detector in a sound level meter. The following Detector speeds settings are available in the 721 or 821:

Slow: The time constant is 1 second (1000 ms). This is the slowest speed. It is commonly used in environmental noise measurements.

Fast: The time constant is 1/8 second (125 ms). This time weighting speed detects changes in sound level more rapidly.

Impulse: The time constant is 35ms for the rise and 1.5 seconds (1500 ms) for the decay. The reason for the double constant is to allow a very short signal to be captured and displayed.

Vibration

The oscillatory movement of a mechanical system (generally taken to be solid). It is used as a broad descriptor of oscillations.

Wavelength (l)

The distance between peaks of a propagating wave with a well defined frequency. It is related to the frequency through the following equation

$$\lambda = \frac{c}{f}$$

where c is the sound speed and f is the frequency in Hz. It has the dimensions of length.

Wavenumber (k)

A number that is related to the wavelength of sound and is used to compare the size of objects relative to the wavelength or the time delay in sound propagation. It is related to wavelength through the following equation

where l is the wavelength, c is the sound speed, f is the frequency in Hz, and w is the radian frequency. It has the dimensions of inverse length.

$$k = \frac{2\pi}{\lambda} = \frac{2\pi f}{c} = \frac{\omega}{c}$$

Windscreen

Air (wind) blowing across the microphone generates pressure fluctuation and vibration on the microphone diaphragm. Thus, your noise exposure reading would include wind noise, an undesirable component. To achieve the best result with the 721 or 821, we recommended using the provided WS001 windscreen.



Larson Davis - a PCB Piezotronics division
LarsonDavis.com

P/N IPRM821.01, SoundExpert 721/821 Reference Manual
Revision B, Firmware Version 1.100
©2023 PCB Piezotronics, Inc.

Larson Davis Corporate Headquarters

3425 Walden Avenue
Depew, NY 14043-2495 USA

888.258.3222 (Toll-free in the US)
716.926.8243
716.926.8215 (USA fax)
sales@larsondavis.com